

GPSMAP® 296

portable aviation receiver

pilot's guide



© Copyright 2004 Garmin Ltd. or its subsidiaries

Garmin International, Inc.

1200 East 151st Street, Olathe, Kansas 66062, U.S.A.

Tel. 913/397.8200 or 800/800.1020

Fax 913/397.8282

Garmin (Europe) Ltd.

Unit 5, The Quadrangle, Abbey Park Industrial Estate, Romsey, SO51 9DL, U.K.

Tel. 44/0870.8501241

Fax 44/0870.8501251

Garmin Corporation

No. 68, Jangshu 2nd Road, Shijr, Taipei County, Taiwan

Tel. 886/2.2642.9199

Fax 886/2.2642.9099

All rights reserved. Except as expressly provided herein, no part of this manual may be reproduced, copied, transmitted, disseminated, downloaded or stored in any storage medium, for any purpose without the express prior written consent of Garmin. Garmin hereby grants permission to download a single copy of this manual onto a hard drive or other electronic storage medium to be viewed and to print one copy of this manual or of any revision hereto, provided that such electronic or printed copy of this manual must contain the complete text of this copyright notice and provided further that any unauthorized commercial distribution of this manual or any revision hereto is strictly prohibited.

Information in this document is subject to change without notice. Garmin reserves the right to change or improve its products and to make changes in the content without obligation to notify any person or organization of such changes or improvements. Visit the Garmin Web site (www.garmin.com) for current updates and supplemental information concerning the use and operation of this and other Garmin products.

Garmin®, GPSMAP®, AutoLocate®, TracBack®, BlueChart®, MapSource®, and See-Thru® are registered trademarks of Garmin Ltd. or its subsidiaries and may not be used without the express permission of Garmin.

December 2004

Part Number 190-00337-00 Rev. C

Printed in Taiwan

INTRODUCTION

Thank you for choosing the Garmin® GPSMAP® 296, an unsurpassed portable aviation receiver that utilizes the proven performance of Garmin GPS and full-featured mapping. Take a moment now to compare the contents of this package with the packing list on the outside of the box. If any pieces are missing, contact your Garmin dealer immediately.

About This Manual

To get the most out of your new navigation system, take time to read this manual and learn the operating procedures for your unit in detail. This manual is organized into the following twelve sections:

The **Introduction** contains the Table of Contents. The **Getting Started** section provides information such as an overview of unit features and how to turn the unit on and adjust the backlight. It also contains a navigation simulation.

The **Basic Operation in Aviation Mode** section provides you with information about navigating with the GPSMAP 296 in Aviation Mode. The **Aviation Mode Pages and Features** section reviews, in detail, the main pages and features of Aviation Mode, such as E6B and the Terrain page.

The **Basic Operation in Automotive Mode** section provides you with information about navigating with the GPSMAP 296 in Automotive Mode. The **Automotive Mode Pages and Features** section reviews, in detail, the main pages and features in Automotive Mode, such as the Trip Data page and creating waypoints.

The **Basic Operation in Marine Mode** section provides you with information about navigating with the GPSMAP 296 in Marine Mode. The **Marine Mode Pages and Features** section reviews the main pages and features in Marine Mode, such as using DSC. For complete information about some of the main pages and features in Marine Mode, refer to the Aviation and Automotive sections.

The **Additional Page and Features** section describes pages and features found in the Main Menu. To learn how to change the settings of the unit, read **Customizing Your GPSMAP 296**.

If you have a GSD 20 Sounder Module connected to your GPSMAP 296, refer to the **Setting Up and Using Sonar** section to learn how the sonar feature operates.

The **Appendix** contains specifications, optional accessories, maintenance information, and other product information. **Read the Safety Information for information about installing and using your GPSMAP 296 safely and responsibly.**

An **Index** is provided at the end of the manual for reference.

Table of Contents

Introduction	i
About This Manual	i
Getting Started	1
Unit Overview	1
Charging the GPSMAP 296	2
Information about Charge Mode	2
Turning On the GPSMAP 296	3
Adjusting the Backlight and Volume	3
Getting Satellite Signals	4
Viewing GPS Status with the GPS tab	4
Receiver Status	5
GPS Tab Options	6
GPS Tips	6
Learning about the Keypad	7
Using the GPSMAP 296	8
Understanding Terms	8
Selecting Options and Entering Data	9
GPSMAP 296 Databases	10
MapSource Detailed Maps	10
Simulated Basic Navigation	11
Activating Simulator Mode	11
Entering a New Location	11
Simulating Navigation	12

Basic Operation In Aviation Mode	14
Aviation Mode Page Sequence	14
Creating a Direct To	15
Viewing Details for the Destination	16
Viewing Frequency Restrictions	17
Finding a Nearby Point	18
Aviation Nearest Categories	18
Selecting a Nearby Point as Your Destination	19
Viewing Details for a Nearby Point.....	19
Viewing Communication Frequencies.....	20
Viewing Airspace Alert Information.....	20
Viewing Additional Airspace Information	21
Setting Airport Criteria	22
Selecting an Approach	23
Understanding Vectors	24
Finding Points on Land	25
Marking a Waypoint	26
Creating a Flight Plan (Route)	27
Following your Flight Plan	28
Track Your Progress on the Map page.....	28
Watch for Terrain and Obstacles Changes.....	28
View the HSI on the Panel Page.....	28
Watch the Pop-up Alerts	28

Aviation Mode Pages and Features	29	Active Route Page	42
Map Page	29	Active Route Page Options	42
Map Orientation	30	Position Data Page	43
Zooming In and Out of the Map	30	Position Data Page Options	43
Panning the Map	31	Flight Log	44
Airspace Information	32	Viewing the Flight Log	44
Clearing Unwanted Details from the Map	33	Deleting Flight Records	44
Measuring Distance	33	Aircraft Information	45
Setting the Bug Indicator	34	Entering Your Aircraft Profile	45
Setting up the Map page	34	Calculating the Weight & Balance	46
Terrain Page	35	E6B Tab	47
Terrain Information	35	Basic Operation In Automotive Mode	49
Obstacle Information	35	Automotive Mode Page Sequence	49
Terrain and Obstacle Color Code	35	Navigating in Automotive Mode	50
Pop-up Alerts	36	Finding an Item	52
Additional Terrain Page Options	36	Using the Find From Feature	52
Setting up the Terrain Page and Alerts	37	Recently Found Items	53
Caution Elevation	37	Viewing the Information Page	54
Look Ahead Time	37	Find Menu Options	54
Alert Sensitivity	37	Creating Routes	55
Panel Page	38	Creating Waypoints	57
Setting up the Panel page	39	Marking Your Present Position	57
Manually Setting a Course	39	Creating Waypoints From the Map	58
VNAV (Vertical Navigation)	40	Creating a Waypoint by Entering Coordinates	59
Using the VNAV Feature	40		
Setting up VNAV	41		

Following an Automotive Route.....	60	Editing and Managing Waypoints	72
Track your Progress with the Map Page.....	60	Viewing the Waypoint on the Map	73
Watch your Trip Data.....	60	Adding a Waypoint to a Route.....	74
Current Route Page in Automotive Mode	60	Averaging the Waypoint's Location	74
Starting and Stopping Navigation.....	60	Projecting a Waypoint.....	75
Editing Your Route	61	Organizing Waypoints into Categories	76
Entering Custom Avoids.....	61	Managing Points.....	77
Creating a Detour.....	62	User Points Tab.....	77
Adding and Editing Stops (Via Points).....	62	Deleting Waypoints	78
Automotive Mode Pages and Features	63	Proximity Points	79
Map Page.....	63	Managing Your Tracks	81
Highway Page	64	Setting up and Saving your Tracks	81
Using the Highway Page	64	Saved Tab.....	83
Highway Page Options	65	Navigating a Saved Track.....	84
Current Route Page.....	66	TracBack Tips.....	84
Saving the Current Route	66	Basic Operation in Marine Mode.....	85
Trip Computer.....	67	Marine Mode Page Sequence.....	85
Trip Computer Page Options	67	Navigating in Marine Mode.....	86
Editing and Managing Routes.....	68	Man OverBoard (MOB)	86
Viewing all of your Saved Routes	68	Marine Mode Pages and Features	87
Using the Route Options.....	68	Map Page.....	87
Manually Transitioning to the Next Waypoint.....	68	Compass Page.....	88
Navigating a Saved Route	69	Compass Page Options	88
Editing a Route	69	Using the Marine Timer.....	89

DSC	90	Viewing Messages	102
Understanding Distress Calls.....	90	Viewing the Temperature	103
Understanding Position Reports.....	90	Changing the Temperature Display.....	103
Receiving DSC Calls.....	91	Reset the Temperature Graph.....	103
DSC Call List.....	91	Customizing Your GPSMAP 296	104
DSC Log.....	92	Setting up the System	104
Receiving a Position Report or Distress Call.....	92	Adding a Welcome Message.....	104
DSC Directory.....	92	Changing the Page Layout and Data Fields.....	105
Making a Distress Call.....	93	Additional Map Data Displayed.....	106
Setting up DSC.....	93	Changing the Display.....	107
Additional Pages and Features	94	Changing the Sounds.....	108
Setting Alarms	94	Changing the System Settings.....	109
Airspace Alarms.....	95	Customizing the Units.....	110
Navigation (Nav) Alarms.....	95	Setting the Timers.....	110
System Alarms.....	96	Changing the Time.....	111
Sonar Alarms.....	96	Restoring Defaults.....	111
Using the Calendar	97	Customizing the Routing and Guidance Settings	112
Day View.....	97	Road Routing Settings.....	112
Week View.....	97	Guidance Settings.....	113
Month View.....	97	Changing the Location Settings	114
Calendar Options.....	97	Changing the Location Format.....	114
Viewing Celestial Information	98	Selecting a Different Map Datum.....	114
Sun & Moon Tab.....	98	Selecting a Different Heading Reference.....	114
Tide Tab.....	99	Changing the Data Format	115
Hunt & Fish Tab.....	101	Advanced NMEA Output Setup.....	117

Setting up and Using Sonar	118	Using xImage for Customized Waypoint Symbols	134
Showing Sonar on the Map Page.....	118	Installing and Removing Data Cards	134
Using the Sonar Page	119	Interfacing.....	135
Adjusting the Sonar Page	120	Removing the Antenna	135
Adjustment Options	120	Learning about GPS.....	136
Resizing the Split Screen	122	Common GPS Terms	136
Using the Pointer on the Sonar Page	122	What is Differential GPS (DGPS)?	136
Setting up the Sonar	123	Differential Field	136
Calibrating the Water Speed	124	What is WAAS?.....	137
Setting up the Sonar Display	125	LORAN TD Setup.....	138
Understanding Sonar.....	126	Map Datums and Location Formats	140
Understanding the Sonar Display	126	Digital Selective Calling (DSC).....	141
Transducer Coverage	127	What is a Maritime Mobile Service Identity (MMSI)?	141
Whiteline	128	How are MMSI assignments obtained?.....	142
Thermoclines	128	United States Non-Federal User	142
Appendix	129	United States Federal User	142
Specifications	129	User Outside the United States	142
Care Information	130	User In Canada.....	142
Cleaning the Unit.....	130	How can Garmin help you with DSC?	142
Storing the GPSMAP 296.....	130	Jeppesen Database Information	143
Immersing the Unit in Water	130	Database Updates	143
Optional Accessories.....	131	Messages	144
Installation Information.....	132	Data Field Options.....	145
Connecting the Power/Data Cable.....	132	Safety and Product Information.....	147
Connecting Your GPSMAP 296 to a Computer	133	Index	152
Information about USB Drivers.....	133		

GETTING STARTED

Unit Overview

Designed with detailed electronic mapping capability, the Garmin GPSMAP 296 is a powerful navigation device suitable for use in aircraft, motor vehicles, and marine vessels. The unit comes with a built-in Jeppesen database that includes worldwide airports and VORs, plus regional NDBs, intersections, airspace boundaries, runway data, and communication frequencies. Additionally, the GPSMAP 296 provides a built-in basemap with cities, interstates, state highways, local thoroughfares, and tide stations. Whether you are planning a flight or creating an automatic turn-by-turn route, the GPSMAP 296 meets all your navigation needs.

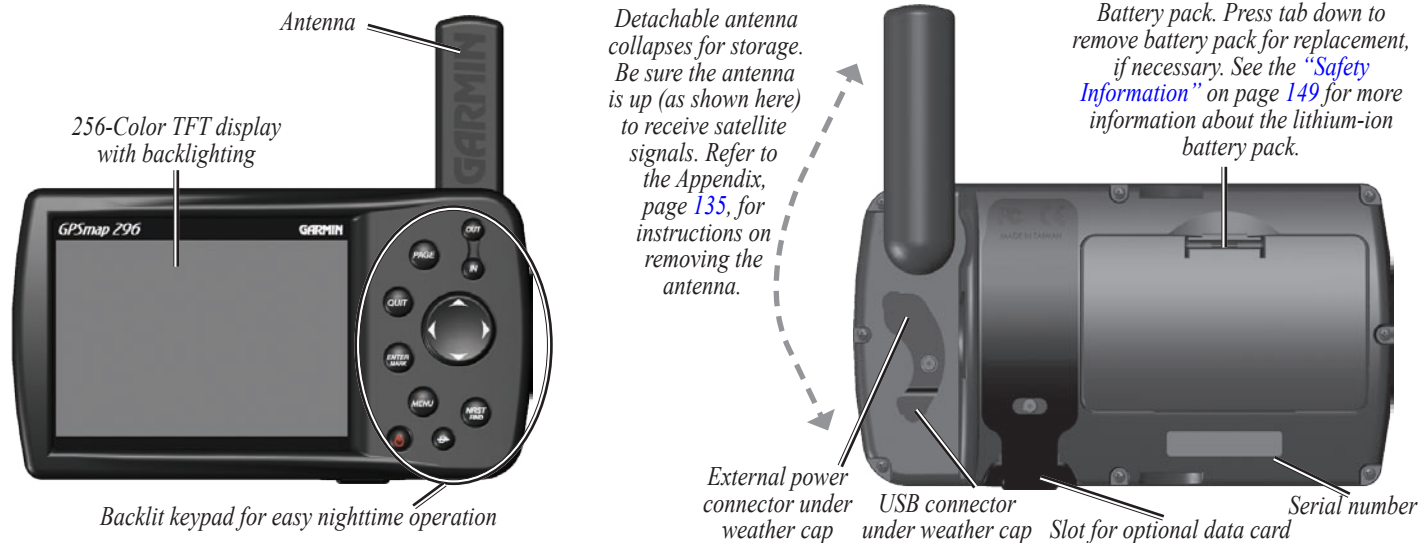

Charging the GPSMAP 296

Before using the unit, you may need to charge the battery in the GPSMAP 296. Simply plug the unit into an external power source to charge. You can use the unit while it is charging.

To charge the unit's battery:

1. Lift the rubber weather cap to expose the power connector on the back of the unit. Refer to the image on page 1 for connector location.
2. Align the notches and push the plug into the connector until fully seated.
3. Plug the 12 Volt adapter into an available AC outlet, or cigarette lighter receptacle if you have a Cigarette Lighter Adapter. Use care when routing the adapter cable, being certain that it does not interfere with vehicle operation.

The unit begins charging as soon as external power is applied. Placing the unit in Charge Mode, as discussed below, charges the unit more quickly than when the unit is turned on and reduces draw on the aircraft/vehicle/boat battery.

Information about Charge Mode

Applying external power to the GPSMAP 296 automatically turns on the unit for full operation. If the battery is present and needs to be charged, the external power source charges the battery while the unit is in use.

If you do not want to use the unit, but you would like to charge the battery, you can put the unit into Charge Mode. Connect the unit to an external power supply. Press and hold the red **POWER** key: Instead of completely turning off, the unit now goes into Charge Mode, as shown below.



Charge Mode



NOTE: While in Charge Mode, the unit draws a small amount of current from the aircraft/vehicle/boat battery. To avoid discharging the vehicle's battery, disconnect the external power cable from the GPSMAP 296 when not in use for several days.

After using the unit a lot, you may notice that the lithium-ion battery in the unit is not holding a charge any more. This is common for lithium-ion batteries. Contact Garmin or your Garmin Dealer to order a Battery Pack replacement if you are experiencing charging issues with your battery.

Turning On the GPSMAP 296

The first time you turn on your new GPSMAP 296, the receiver must collect satellite data and establish its present position. To ensure proper initialization, the GPSMAP 296 is shipped from the factory in AutoLocate mode, which allows the receiver to “find itself” anywhere in the world. Before you turn on the unit to start initialization, be sure that the antenna is rotated up as shown on page 1, and it has a clear and unobstructed view of the sky to receive satellite signals.

To turn on and off the GPSMAP 296:

1. Press and hold the red **POWER** key. When the unit powers on, a tone sounds and the Warning page displays.



Warning Page

2. Read and be sure you understand the warning. If you have external devices connected, the devices are listed here. Press **ENTER** to continue.

3. To turn off the GPSMAP 296, press and hold the red **POWER** key again.

Adjusting the Backlight and Volume

You may want to adjust the backlight to see the display better. If you are using the optional External Speaker with 12/24-Volt Adapter Cable with the GPSMAP 296, you may want to adjust the volume level of the speaker.

To adjust the backlight level or volume:

1. Press and quickly release the **POWER** key.
2. Press the **Rocker** key Up to increase the brightness or Down to decrease. Press Right to raise the volume or left to lower.
3. Press **ENTER** or **QUIT** to close the Backlight/Volume adjustment window. Press **MENU** to view the options menu.

Battery Time Remaining and Power Source Indicator

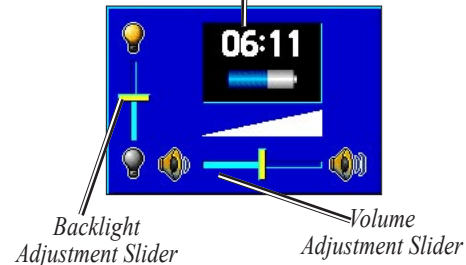

Getting Satellite Signals

After you turn on the GPSMAP 296, the unit automatically begins searching for satellites. The GPS page is displayed while the unit is gathering satellite signals and acquiring a fix, which should take only a few minutes. While the GPSMAP 296 is getting satellite signals, the GPS page displays the status as “Acquiring Satellites.”

It may take a few minutes to acquire satellites and display your current location on the map. Be patient as the unit acquires satellite data. To get signals more quickly, be sure the antenna is raised to the up position shown in the image on page 1.



GPS Page





NOTE: While acquiring satellites, the Map page may display the wrong location, such as China. This does not mean your unit has the wrong data loaded. It simply means you need to wait a few more minutes to acquire satellites and find your current location.

Viewing GPS Status with the GPS tab

The GPS tab provides a visual reference of satellite acquisition, receiver status, and accuracy. The sky view and signal strength bars give an indication of what satellites are visible to the receiver and whether they are being tracked.

As the receiver locks onto satellites, a signal strength bar appears for each satellite in view, with the appropriate satellite number underneath each bar. The numbers displayed below each bar represent the particular satellite that is being received. Numbers above 33 indicate WAAS satellites.

The sky view shows a birds-eye view of the position of each satellite relative to the receiver’s last known position. The outer circle represents the horizon (north up), the inner circle represents 45° above the horizon, and the center point represents a position directly overhead. You can also set the sky view to a Track Up configuration, causing the top of the sky view to align along your current track heading.

A power source indicator shows the unit is operating off battery power () , that the unit is charging () , or that an external power source is in use ().

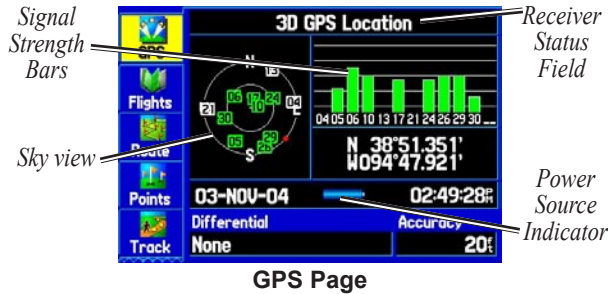

GPS Page

The progress of satellite acquisition is shown in three stages:

- **No signal strength bars**—the receiver is looking for the satellites indicated.
- **White signal strength bars**—the receiver has found the satellite and is collecting data.
- **Green signal strength bars**—the receiver has collected the necessary data from this satellite.

As soon as the GPSMAP 296 has collected the necessary data from the best satellites in view to calculate a fix, the status field indicates the status of the receiver. The unit then updates the position, date and time.

Receiver Status

The Receiver Status field displays one of the following conditions:

- **Searching the Sky**—the receiver is looking for satellites.
- **AutoLocate**—the receiver is looking for any satellite whose almanac has been collected, which can take up to 5 minutes.
- **Acquiring Satellites**—the receiver is looking for and collecting data from satellites visible at its last known or initialized position, but has not acquired a fix.
- **2D GPS Location:** At least three satellites have been acquired and a two-dimensional position fix has been calculated. “2D Differential” appears when you are receiving DGPS corrections in 2D mode and a “D” appears on the strength bar of satellites being corrected.
- **3D GPS Location:** At least four satellites have been acquired and a three-dimensional fix has been calculated. “3D Differential” appears when you are receiving DGPS corrections in 3D mode and a “D” appears on the strength bar of satellites being corrected.
- **Lost Satellite Reception**—the receiver is no longer tracking enough satellites for a 2D or 3D fix.
- **Receiver Not Usable**—the receiver is unusable, possibly due to interference or abnormal satellite conditions. Turn the unit off and back on to reset.
- **Simulating GPS**—the receiver is in simulator mode.
- **GPS Off**—the GPS receiver is turned off.

GPS Tab Options

Press **MENU** two times to open the Main Menu. Use the **Rocker** key to highlight GPS. Press **MENU** to open the options menu:



GPS Tab Options Menu

Start/Stop Simulator—activates and deactivates simulator mode, which is particularly helpful when learning how to use your unit.

WAAS On—enables WAAS capability. Refer to page 137 of the “Appendix” for more information about WAAS.

Track/North Up—orients the sky view display on the GPS tab to north up or track up.

New Altitude—allows you to manually enter your altitude.

New Location—allows you to enter a new location automatically or using the map. When in Aviation Mode, you can enter the airport identifier.

GPS Tips

While the receiver is gathering information, your location on the map may display as different from where you actually are located. Be patient; as soon as the receiver gathers enough satellite information, your proper location is displayed on the map.

Any time you have traveled more than 600 miles with the GPS receiver turned off, the receiver may take longer than normal to initialize and find your location.

The GPS receiver can lose satellite signals due to interference from such items as buildings, tunnels, and heavy tree cover. Monitoring the GPS status is recommended.

To learn about GPS, refer to “[Learning about GPS](#)” on page 136.

Learning about the Keypad



Press the **IN** key to adjust the map scale to show a smaller area with more detail (zoom in).



Press the **OUT** key to adjust the map scale to show a larger area with less detail (zoom out).



Press the **PAGE** key to cycle through the main pages in sequence and exit a submenu page. Press and hold to switch between Aviation, Marine, and Automotive Modes.



Press **QUIT** to cycle the unit through the main pages in reverse sequence, revert to the previous value in a data entry field, or cancel an unintended function.



Press **ENTER** to select a highlighted option. When entering data, it allows you to initiate entry and accept the selected value. Press and hold for more than one second to mark your current location as a waypoint.



Press **MENU** to display a menu of available options for the current page. Press **MENU** twice to display the Main Menu.



Press the **NEAREST (NRST/FIND)** key to display the nearest airports, nav aids, points of communication, and airspace boundaries in Aviation Mode. In other modes (or when pressed multiple times in Aviation Mode), press to display the Find Menu.



Press the **Direct To** key to activate a Go To to airports, nav aids, recently-used waypoints, or user-created waypoints. Press and hold to display additional information for the current destination.

While in Automotive Mode, press and hold to display the Next Turn page and announce the next turn when using the external speaker.



Press and hold the **POWER** key for more than one second to turn the unit on and off. Briefly press and release to adjust the backlighting and external speaker volume.



Use the **Rocker** key to highlight options and to enter data. Also use to pan the arrow on the Map page.

Using the GPSMAP 296

This section explains how to enter and select information with the GPSMAP 296.

Understanding Terms

The GPSMAP 296 unit's advanced keypad system is designed to allow quick, convenient selection of navigation options and data entry. As you progress through this *Pilot's Guide*, you will often be directed to press a specific key or highlight a field on the screen. When you are directed to press a key, you should press and quickly release the key. If the key needs to be held down for a period of time to activate a secondary function, the instructions will tell you to do so. When a field is selected on the screen, it is highlighted in yellow. The position of the highlight is controlled by the **Rocker** key.

The following features are referred to throughout this manual.

Highlight—move the highlighted area on the screen Up, Down, Left, or Right with the **Rocker** key to select individual fields. Moving the highlight to a given location allows you to make a selection, begin data entry, or scroll through a list.

Field—the location on a page where data or an option may be entered and displayed. Select (highlight) a field using the **Rocker** key to begin entering data or selecting options.

On-Screen Button—similar to “field.” Use the **Rocker** key to highlight a button and press **ENTER** to select the button.

Scroll Bar—when viewing a list of items too long to display on the screen, a scroll bar appears along the right side of the list. The position of the scroll bar indicates which portion of the list is currently displayed. To scroll through a list, press Up or Down on the **Rocker** key.

Default—the factory setting saved in the unit's memory. You can change the settings as you like, but you can also revert to the factory (default) settings when you select **Restore Defaults**.

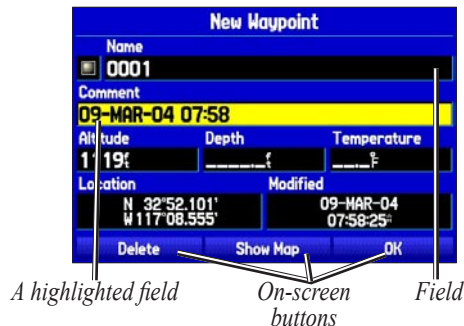

Selecting Options and Entering Data

To enter data and select options, you must use the **Rocker** key to highlight, select, or choose an item in a list or a field on the screen. Use the **ENTER** key and the **Rocker** key to select options, enter names and numbers in data fields, and activate your selections.

To select and activate an option:

1. With any page displayed, press **MENU**. An options menu appears with a list of optional features for that page.
2. Use the **Rocker** key to move the highlight Up, Down, Right, or Left on the menu to your desired selection.
3. Press **ENTER** to activate the feature. Another window may then appear with more options. If so, select the desired option and press **ENTER** again.



Selecting an option from an options menu

To exit a menu or return to the previous setting:

Press **QUIT**.

The **QUIT** key moves backwards through your steps. When pressed repeatedly, **QUIT** returns to the starting page.

To select and activate an on-screen button:

1. On a page with on-screen buttons, use the **Rocker** key to highlight the desired on-screen button.
2. Press **ENTER**.





On-Screen Button

To practice entering data, try marking a waypoint and customizing one of the waypoint properties, such as the waypoint name.

To mark your current location as a waypoint, press and hold **ENTER/MARK** until the New Waypoint page appears.

To enter data in a data field:

1. Use the **Rocker** key to highlight the desired data field and press **ENTER** to activate the field.
2. Press Up or Down on the **Rocker** key to select characters. Press Right to move to the next character or press Left to move back to the previous character. If there are two lines of data, keep pressing Right to drop to the next line.

New Waypoint Saved (Delete to Remove)		
Name	Category	
  _____	Unfiled	
Comment		
02-SEP-04 11:52		
Altitude	Depth	Temperature
440'	46.7'	58.1°F
Location		Modified
N 32°48.944'		02-SEP-04
W 117°07.538'		11:52:11
Delete	Show Map	OK

Entering data



TIP: To clear the entire data field, highlight the left-most character field and press Left once more on the **Rocker** key.

3. After entering the desired data, press **ENTER**.

Not all fields are programmable. When you are on a page with fields that are not selectable, the highlight skips over them.

GPSMAP 296 Databases

Your GPSMAP 296 comes with a Jeppesen® database, an Obstacle database, a Terrain database, a Voice Guidance database, and a basemap. You also should update your Jeppesen database to use the most current data. Refer to page 143 in the “Appendix” for more information.

MapSource Detailed Maps

Optional Garmin Data Cards and MapSource CD-ROMs enhance the versatility of your GPSMAP 296. With optional MapSource City Select® data, you can view listings of nearby restaurants, lodging, shopping centers, attractions, and entertainment, and even retrieve addresses and phone numbers for any listed location. With optional BlueChart data, you can access marine nav aids, wrecks, obstructions, and anchorage locations.

The included USB Interface Cable or an optional PC Interface Cable (with a serial connector) is used to transfer MapSource CD-ROM data to the optional Data Card.

Refer to the Garmin Web site at <http://www.garmin.com/cartography/> for compatible MapSource products.

Simulated Basic Navigation

To help you get to know your GPSMAP 296, you can use the unit in Simulator Mode. Simulator Mode is also helpful for practicing with the unit indoors or when no satellite signals are available. All waypoints and routes created in Simulator Mode are retained in memory for future use. The following section describes how to use simulator mode and walks you through some basic navigation using the simulator.

Activating Simulator Mode



NOTE: Do not attempt to navigate using Simulator Mode. When the unit is set to Simulator Mode, the GPS receiver is turned off. Any Satellite Signal Strength Bars displayed are only simulations and do not represent the strength of actual satellite signals.

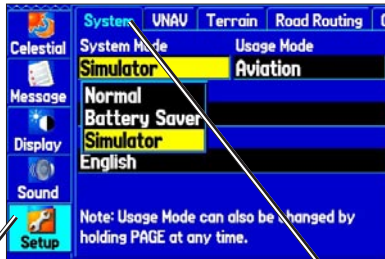

Setup tab of Main Menu

System tab

To put the unit into Simulator Mode using the GPS tab:

1. Press **MENU** twice to display the Main Menu.
2. Highlight **GPS** from the vertical menu.
3. Press **MENU** to open the GPS tab options menu.
4. Highlight **Start Simulator** and press **ENTER**.

Entering a New Location

From the GPS options menu you can enter a **New Location** and **New Altitude** to simulate from.

To enter a New Location using the map:

1. Press **MENU** twice and highlight **GPS** from the vertical menu.
2. Press **MENU** to open the options menu.
3. Highlight **New Location**, and press **ENTER**.
4. Highlight **Use Map** and press **ENTER**.
5. Use the **Rocker** key to move the panning arrow to the desired location on the map and press **ENTER**.

You can also select a New Location by entering an airport identifier (code). Select **Use Identifier** from the GPS tab options menu. Enter the airport code using the **Rocker** key. Refer to page 15 for complete instructions about entering airport identifiers and cities.

Simulating Navigation

To get a feel for navigating with the GPSMAP 296, it is a good idea to practice navigation in Simulator Mode. The following is a basic exercise for finding and navigating to a destination in Aviation Mode. For this simulation we have set our location to San Diego, California.

To find an aviation destination and simulate navigation in Aviation Mode:

1. Be sure the GPSMAP 296 is set to Simulator Mode and your location is set to San Diego, California (see “[Activating Simulator Mode](#)” on the previous page).
2. Press the **Direct To**  key.
3. Highlight the airport identifier (code) and press **ENTER** to enter a new identifier to use as your destination.
4. Enter “KVGT” for the North Las Vegas airport and press **ENTER**. The highlight automatically jumps to the on-screen **Go To** button.
5. Press **ENTER** to start navigating to North Las Vegas airport. The GPSMAP 296 switches to the Map page. A magenta line shows the direct route from your current location to your **Go To** destination. Press **IN** or **OUT** to adjust the zoom level.

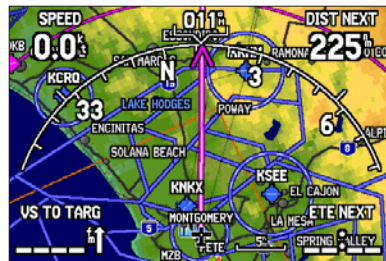

Simulated navigation displayed on the Map page (Aviation Mode)

6. Press the **Page** key two times to display the Panel page.
7. Press Up on the **Rocker** key to increase the speed. The aircraft symbol now begins moving on the magenta route. Use the **IN** and **OUT** keys to change your altitude.
8. Press **QUIT** or **PAGE** to return to the Map page. Press **IN** or **OUT** to adjust the zoom level. Observe the movement of the aircraft symbol  as the unit simulates navigation. If desired, press **PAGE** or **QUIT** to view the simulated navigation on the other main pages.

Now we will simulate navigation in the Automotive Mode. To switch between Aviation and Automotive Mode, press and hold **PAGE**. Use the **Rocker** key to select **Automotive** and press **ENTER**.

To find a land destination and simulate navigation in Automotive Mode:

1. Be sure the GPSMAP 296 is set to Simulator Mode and your location is set to San Diego, California (see “Activating Simulator Mode” on page 11).
2. Put the GPSMAP 296 in Automotive Mode by pressing and holding **PAGE**. Highlight **Automotive** and press **ENTER**.
3. Press the **NRST/FIND** key to open the Find Menu.
4. Highlight **Cities** and press **ENTER**. Use the **Rocker** key to select a city from the list and press **ENTER**. For our example, we selected National City, CA.
5. With **Go To** highlighted on the city information page, press **ENTER**. The GPSMAP 296 switches to the Map page. A magenta line shows the turn-by-turn route following roads from your current location to your Go To destination.

Observe the movement of the position marker (triangle) as the unit simulates navigation. You do not need to adjust the speed when simulating in Automotive Mode.

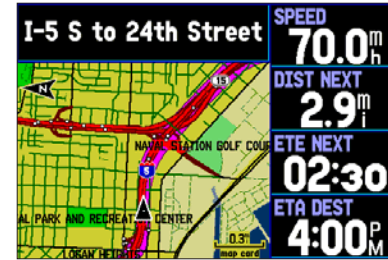

Simulated Automotive navigation displayed on the Map page

6. If desired, press **IN** or **OUT** to adjust the zoom level. Press **Page** or **Quit** to view the simulated navigation on the other main pages.

Continue to use the Simulator to practice navigation as needed. When you are ready to navigate on your own, turn the Simulator off.

To turn off the Simulator:

1. Turn the unit off by pressing and holding the red **POWER** key.
2. Turn the unit back on by pressing and holding the red **POWER** key. The unit powers on in **Normal** Mode.



TIP: You can activate and deactivate the Simulator through the Setup tab or GPS tab options menu of the Main Menu.

BASIC OPERATION IN AVIATION MODE

This section explains some of the more common operations you will perform with your GPSMAP 296, such as navigating a flight plan.

Aviation Mode Page Sequence

The GPSMAP 296 offers three usage modes, Aviation Mode (default), Automotive Mode, and Marine Mode. The main pages are linked together in a series that you can cycle through by pressing **PAGE** to move forward and **QUIT** to reverse. Each page also has an options menu that allows you to customize each page (in all three modes) to your preferences and/or select features that specifically relate to that page. To view the options menu for any page, press **MENU**.

Aviation Mode features five main pages: Map page, Terrain page, Panel page, Active Route page, and Position Data page. An example of each page in Aviation Mode appears below. Each of these pages has a specific use and each page is discussed later in this manual. The Aviation Mode is the default mode for the GPSMAP 296. This manual first addresses each page, such as the Map page, as displayed in the Aviation Mode. The manual then describes the page as shown Automotive and Marine Mode, if major differences exist.



To switch usage modes:

1. Press and hold the **PAGE** button.
2. Use the **Rocker** key to select either Aviation, Automotive, or Marine and press **ENTER**.

Creating a Direct To

In Aviation Mode, press the **Direct To** \rightarrow key to select a destination. When a Go To or route is currently in use, holding the **Direct To** \rightarrow key down briefly displays a detailed information page for the current destination.

In Marine or Automotive Mode, pressing the **Direct To** \rightarrow key displays the Navigate menu, which allows you to activate navigation or edit a route. Also, in Marine Mode, pressing the **Direct To** \rightarrow key twice creates a Man OverBoard waypoint and starts navigating to that point.

Press **MENU** on any tab of the Go To page to open an options menu for that tab. Depending up the tab you have selected, you can **Show Details**, **Select Approach**, **Select Route**, **Find Land Points**, and **Remove Point**.

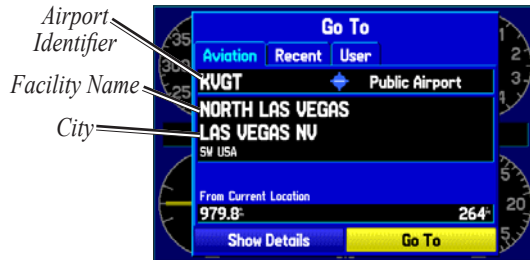

Go To Page: Aviation Tab

To go to an airport or navaid:

1. Press the **Direct To** \rightarrow key to display the Go To page. Use the **Rocker** key to display the **Aviation** tab.
2. Press Up or Down on the **Rocker** key to select the identifier, facility name, or city field and press **ENTER**.
3. Use the **Rocker** key to **ENTER** the desired word to search for. Press Up and Down to change the highlighted character and Right to move to the next character field. As you scroll through the characters the GPSMAP 296 displays database entries with the same characters you have entered to that point. If more than one entry exists in the database for the characters you have entered, a pop-up window appears. Use **ENTER** and **Rocker** key to select the point.
4. Press **ENTER** once the desired point is displayed.
5. With the on-screen **Go To** button highlighted, press **ENTER**. The GPSMAP 296 creates a course from your present position to the selected destination.

To go to a recently-used or user-created waypoint:

1. Press the **Direct To** \rightarrow key to display the Go To page. Use the **Rocker** key to select the **Recent** or **User** tab.

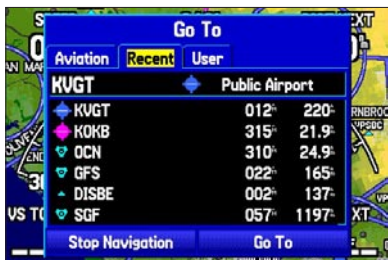
**Go To Page: Recent Tab**

2. Use the **Rocker** key to highlight the desired point from the list. Press **ENTER**.
From the **User** tab, you can also select the top waypoint name line and then spell out the desired waypoint name using the **ENTER** and **Rocker** keys.
3. Highlight the on-screen **Go To** button and press **ENTER**. A course is plotted from your present position to the selected destination.

Viewing Details for the Destination

The **Show Details** option displays detailed information for your destination waypoint or the next waypoint in a route. This feature is handy for retrieving airport information, such as communication frequencies and runway information. You can view details by using the options menu or simply by selecting the **Show Details** button on the Go To page and pressing **ENTER**.

To view the details for the selected destination:

1. Use one of the following methods to view Details about the selected (highlighted) destination:
 - Press **MENU** to open the options menu. Use the **Rocker** key to highlight **Show Details** and press **ENTER**.
 - Press and hold the **Direct To** \rightarrow key.
 - Use the **Rocker** key to highlight the **Show Details** button and press **ENTER**.
2. A new screen appears showing file tabs along the top of the screen. If necessary, use the **Rocker** key to select the desired tab and view the information on that tab.



Airport Tab of Details Page

3. Highlight **Show Map** and press **ENTER** to view the item on the map. Press **QUIT** when done. Highlight **OK** and press **ENTER** to return to the Go To page.

When viewing information for the Runway or Approach tabs, use the **Rocker** key to highlight the runway designation or approach name and press **ENTER**. Then press Up or Down on the **Rocker** key to scroll through available runways and approaches. Press **ENTER** to select the runway or approach for which you would like to view additional information.

Viewing Frequency Restrictions

The Comm tab of the Airport Details page provides a list of communication frequencies for that airport. Some frequencies may be noted with an asterisk (*), which indicates that the frequency has usage restrictions. You can display the usage restriction information on your GPSMAP 296.

To view usage restrictions for a communication frequency:

1. With the Comm tab selected, use the **Rocker** key to highlight any frequency with usage restrictions (noted with an asterisk) and press **ENTER**. A **Usage Restrictions** page appears describing the restrictions for the selected frequency.



Usage Restrictions Page

2. To return to the Comm information page, press **ENTER**.

Finding a Nearby Point

In Aviation Mode, press the **NRST/FIND** key to open the Nearest Pages. These pages provide detailed information on the nearest airports, airport weather sources, user waypoints within 200 miles of your present position, and other points.

In Marine and Automotive Modes, press the **NRST/FIND** key to open the Find Menu. You can easily search Waypoints, Cities, Exits, and Tide Stations using the Find Menu.

Airport	Wx	VOR	NDB	INT	User	ARTCC	FSS
Airport	Bearing	Distance	Runway	Frequency			
◆ KMKX	191 ^h	3.8 ⁿ	12000 ^f	135.20 st			
◆ KMYF	179 ^h	6.8 ⁿ	4500 ^f	119.20 st			
◆ KSEE	118 ^h	9.2 ⁿ	5300 ^f	120.70 st			
◆ KRNM	043 ^h	12.0 ⁿ	5000 ^f	119.87 st			
◆ KSAN	186 ^h	12.2 ⁿ	9400 ^f	118.30 st			
◆ KNZY	188 ^h	14.6 ⁿ	8000 ^f	135.10 st			
◆ KCRD	312 ^h	14.8 ⁿ	4800 ^f	118.60 st			
◆ KOKB	312 ^h	21.3 ⁿ	2700 ^f	123.00 st			
● KNRS	168 ^h	21.6 ⁿ	4900 ^f	120.65 st			

Nearest Page: Airport Tab

While in Aviation Mode

Press **MENU** when the Nearest page is open to display the Nearest page options menu. You can **Show Arrows** (or **Show Bearing**) and **Set Airport Criteria**.

Aviation Nearest Categories

In Aviation Mode, the Nearest Pages contains the following information:

Airport—nearest 15; identifier, bearing, distance, length of the longest runway, and common traffic advisory (CTAF) or tower frequency.

Wx (Airport Weather Sources)—nearest 15 airport weather information sources including AWOS, ASOS, and ATIS.

VOR (VHF Omnidirectional Radio Beacons)—nearest 15; identifier, facility type (symbol), bearing, distance, and frequency.

NDB (Non Directional Beacons)—nearest 15; identifier, facility type (symbol), bearing, distance, and frequency.

INT (Intersection)—nearest 15; identifier, bearing, and distance.

User (Waypoints)—nearest 15; name, bearing, and distance.

ARTCC (Air Route Traffic Control Center)—nearest 5; bearing, distance, and frequency.

FSS (Flight Service Station)—nearest 5; bearing, distance, frequency, and VOR (for duplex operations).

Airspace—up to 15 (depending on number of alerts provided); name, time to entry (when applicable), and status.

Selecting a Nearby Point as Your Destination

In an emergency, you can press a few keys to have the GPSMAP 296 guide you to the closest point to land.

To select a nearby point as your destination:

1. Press the **NEAREST** key.
2. Use the **Rocker** key to select the desired file tab along the top of the page.
3. Highlight the desired point using the **Rocker** key.
4. Press **Direct To** \rightarrow . The Go To page opens for the selected point. Or you can press **ENTER** to display the Information page (Details page).
5. Press **ENTER** when **Go To** is highlighted.

Viewing Details for a Nearby Point

To view details for a nearby point:

1. Press **NEAREST** key to display the nearest pages. Select the desired file tab.
2. Use the **Rocker** key to highlight the desired item on the list and press **ENTER**. The corresponding information page appears.



Information Page for a VOR

On airport information pages, use the **Rocker** key to select the file tabs across the top of the information pages and display the desired airport data.

3. Press **QUIT** to return to the Nearest Pages. You can also highlight any one of the on-screen buttons to perform that action, such as **Show Map** or **Go To**.

Viewing Communication Frequencies

The Nearest Pages list up to five nearest flight service station (FSS) and air route traffic control center (ARTCC) points of communication. The closest communication point is displayed first, with additional points available when selected. For duplex operation, the corresponding VOR is listed (by identifier) and the transmit and receive frequencies are denoted by a TX and RX respectively.

To view additional communication frequencies:

1. Press **NEAREST** to open the Nearest Pages.
2. Use the **Rocker** key to select the **ARTCC** or **FSS** file tab.
3. Press the **Rocker** key Down to highlight **Center** or **Station** (depending which tab you are on) and press **ENTER**.



ARTCC Tab

4. Select the desired numbered item from the list and press **ENTER** to display the communication information. The lowest numbers on the list are the closest communication points.

Viewing Airspace Alert Information

When an airspace alert appears, press the **NEAREST** key to automatically display nearby airspace information in the Airspace tab. This information includes name, time to entry (if applicable), and status. Normally, only one or two airspace alerts will occur at a time, but with sectorized controlled airspace, such as many Class B areas, you may have more. Status information can appear as follows:

Ahead—your projected course will take you inside an airspace within the next ten minutes or less.

Near—you are within two nautical miles of an airspace but not projected to enter it.

Near & Ahead—you are within two nautical miles of an airspace and your current course will take you inside the airspace.

Inside Airspace—you are within the boundaries of the airspace.

Viewing Additional Airspace Information

From the Nearest Pages, you can display additional airspace information, such as floor and ceiling limits or communication frequencies.

To view additional airspace information:

1. Once an airspace alert appears, press **NEAREST** to display the Nearest Pages and the airspace information. If you are already viewing the Nearest Pages, use the **Rocker** key to select the **Airspace** tab.

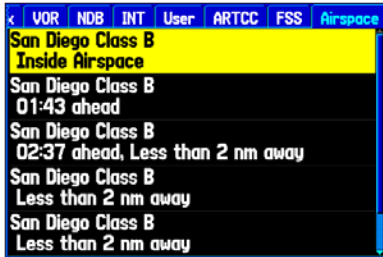

Nearest Pages: Airspace Tab

2. Use the **Rocker** key to select the desired airspace alert entry on the page, then press **ENTER**. An information page opens to display the controlling agency, status, and floor/ceiling limits.
3. To display a communication frequency for the airspace, select the **Frequencies** button and press **ENTER**.

To return to the Nearest Pages, select the **OK** button and press **ENTER**.



***TIP:** When an airspace alert appears, press **NEAREST** to automatically display nearest airspace information. Press **NEAREST** a second time to quickly display the nearest airports list. Press **NEAREST** a third time to display the Find Menu.*

Setting Airport Criteria

From the Nearest Airport tab, an options window allows you to filter out airports that do not meet a defined criteria. This allows you to only show airports with a desired surface type and sufficient runway length. Pilots of larger, high-performance aircraft may define the nearest airport search to ignore airports where it would be difficult, if not impossible, to land.

Runway Surface—allows you to set criteria for the type of surface on the runway:

Any—displays any runway, regardless of surface type, including water landing facilities.

Hard Only—displays only runways with a concrete, asphalt, or similar sealed surface.

Hard or Soft—displays all runways except water landing facilities.

Water Only—displays only water landing facilities.

Minimum Runway Length—allows you to enter a specific length for the shortest runway allowed.

To enter airport criteria:

1. Press **NEAREST** and open the **Airport** tab.
2. Press **MENU** to display the options menu.

3. Select **Set Airport Criteria** and then press **ENTER**. A pop-up window appears with the current settings for runway surface and minimum runway length.

Airport	Wx	VOR	NDB	INT	User	ARTCC	FSS
L22	358M	4.9%	4300'			123.00MHz	
L80						122.80MHz	
KPSP						119.70MHz	
KUDD						122.80MHz	
NXP						135.52MHz	
KBNG						122.80MHz	
KTNP	065M	24.5%	5500'			122.80MHz	
L35	288M	24.9%	5800'			123.05MHz	
KTRM	139M	28.6%	8500'			123.00MHz	

Runway Surface: Any
Minimum Runway Length: 0'

Airport Criteria Page

4. With the runway surface field highlighted, press **ENTER**. Select the desired surface type and press **ENTER**.
5. Highlight the minimum runway length field and press **ENTER**. Use the **Rocker** key to enter the minimum acceptable runway length. Press **ENTER**.



NOTE: Use caution when changing the nearest airport criteria. In an emergency, a short runway is still typically preferable to an off-field landing. If you set the runway length too low or exclude many runway surfaces, you may not be alerted to a nearby airport that otherwise would be listed.

Selecting an Approach



NOTE: The approaches provided in the Jeppesen database are for monitoring purposes only. The GPSMAP 296 is not an IFR-approved instrument and should not be used as a primary source of navigation guidance in instrument conditions.

When you select an approach, it replaces the destination airport with the sequence of waypoints for the selected approach. Keep in mind that the airport must have a published approach (GPS, RNAV, VOR, NDB, localizer, or ILS) and only the final course segment (usually from final approach fix to missed approach point) of the published approach is available in the GPSMAP 296.



NOTE: When using a route, the selected approach overrides your current route. The original route is saved in the Routes tab.

You can select an approach several ways:

- Press the **Direct To** \rightarrow key and press **MENU** on the Go To page, as described in the steps to the right.
- From the Active Goto (or Active Route) page, press **MENU**.
- From the Airport Details page, select the Approach tab.

To select an approach for the destination airport:

1. Press the **Direct To** \rightarrow key to display the Go To page. Select the destination you want to travel to.
2. Press **MENU** to open the options menu. Highlight **Select Approach** and press **ENTER**.
3. Use the **Rocker** key to select the approach from the pop-up window and press **ENTER**.

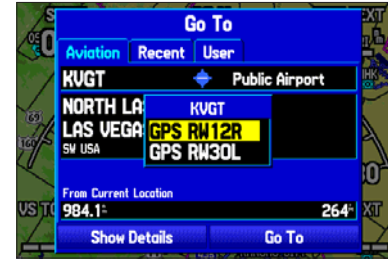

Selecting an Approach

4. A Vectors? pop-up window appears. See the following page for more information on vectors. Use the **Rocker** key to select **Yes** or **No** and press **ENTER**. The GPSMAP 296 removes the destination airport from the Go To and replaces it with the approach waypoints.

Understanding Vectors

The Vectors? option, which appears after you select an approach, determines how you will navigate to the final approach waypoint.

If you select **Yes**, the GPSMAP 296 creates an extension of the final course, beyond the final approach waypoint in the database (final approach fix [FAF]). On the Active Route page, a Vector to Final symbol appears beside the first approach waypoint.

Waypoint	Course	Distance	ETA
BEW1H	136 ^M	222 ^M	—:— ^A
RW12R	227^M	227^M	—:— ^A
Total	136^M	227^M	—:— ^A

Active Approach Page

Using vectors in the approach

The GPSMAP 296 provides no guidance to the inbound course. The course deviation needle on the graphic HSI remains off-center until you are established on this final approach course. The HSI automatically slews (rotates to show the direction) to the inbound course. The Map page displays an extension of the final approach course using a bold magenta line.

If **No** is selected for the Vectors? option, the GPSMAP 296 creates a straight-line course directly to the first waypoint in the approach (from wherever you are when you initiate the approach). This works much like any other route with course guidance from point to point and a turn usually required as you cross each waypoint.



NOTE: Steep Turns are not allowed on an IFR (Instrument Flight Rules) approach. Follow plate or air traffic control instructions to complete the approach without a steep turn.

If air traffic controls clears your approach to an airport, loading the approach cancels your Direct To and initiates a route to the FAF. Load the approach only when cleared by air traffic control.

You can cancel an approach and/or vectors several ways:

- Press the **Direct To** **➔** key and press **MENU** on the Go To page, as described in the steps below.
- From the Active Goto (or Active Route) page, press **MENU**.

To cancel the vectors and/or approach:

1. Press the **Direct To** **➔** key to display the Go To page. Or, open the Active Route page. Press **MENU** to open the options menu.
2. Highlight **Cancel Approach** and press **ENTER** to cancel the entire approach. If you enabled Vectors, highlight **Cancel Vectors** and press **ENTER** to navigate directly to the FAF.

Finding Points on Land

To take full advantage of the trip-planning capabilities of the GPSMAP 296, you can find points on the land and then create a turn-by-turn route (auto-route) to that point. For example, you can find a restaurant to eat dinner at once you land.

To Find Land Points:

1. Press the **Direct To**  key to display the Go To page.
2. Press **MENU** to open the options menu.



Go To Page Options Menu

3. Highlight **Find Land Points** and press **ENTER**. The Find Menu opens.



Find Menu

4. Press **MENU** to select the search method. For example, if you want to find a land point near your destination, select **Near Destination** and press **ENTER**.
5. Highlight the find menu icon for the desired category and press **ENTER**.
6. Enter the necessary information, such as the restaurant name and press **ENTER**. Refer to “Finding an Item” on page 52 for complete information.
7. Select **Save** to save the location as a waypoint to use later when creating a route. Select **Show Map** to show the desired location on the map, or select **OK** to return to the search results list.

You can use the saved waypoint as a destination once you are on the ground. Simply press **Direct To**  and select the saved waypoint from the **User List**.

Marking a Waypoint

Waypoints are locations or landmarks you record and store in your GPSMAP 296. They may be checkpoints on a route or significant ground features.

The **ENTER/MARK** key lets you quickly capture your present position to create a new waypoint. You must have a valid 2D or 3D satellite fix to mark your position. Press **MENU** twice and open the GPS tab to view your satellite receiver status.

For more information about editing waypoints, see the “[Editing and Managing Waypoints](#)” section beginning on page 72.

To mark your present position:

1. Press and hold **ENTER/MARK** until the Mark Waypoint page appears.
2. To accept the waypoint with the default name (“Waypoint”), use the **Rocker** key to highlight **OK** and press **ENTER**.

To mark a selected location as a waypoint:

1. Press **PAGE** to open the Map page.
2. Use the **Rocker** key to move the arrow to the location you want to save as a waypoint.
3. Quickly press and release **ENTER/MARK** to open the information page for the map item.



Saving the selected item as a waypoint

4. To save the waypoint, use the **Rocker** key to highlight **Save** and press **ENTER**.
5. To accept the waypoint with the default name, highlight **OK** and press **ENTER**.

Creating a Flight Plan (Route)

You can create a Flight Plan (or route) using the Route page in the Main Menu. The Route is then saved for future use. You can also create a route using the Active Route page for immediate use. For more information, refer to “[Creating Routes](#)” beginning on page 55 and “[Editing and Managing Routes](#)” beginning on page 68.



NOTE: After you perform an update to your Jeppesen Database, verify that all of your flight plans in your unit are still current. If there is an obsolete Jeppesen aviation point in a saved route, the route will be locked and unusable. You need to create a new route with current Jeppesen Database points.

To create a route:

1. Press **MENU** two times to open the Main Menu.
2. Use the **Rocker** key to highlight **Routes** and press **ENTER**.
3. Press **MENU** to display the options menu. Use the Rocker key to highlight **New Route** and press **ENTER**, or highlight the first blank line and press **ENTER**.
4. Press **MENU** to display the options menu. Use the Rocker key to highlight **Add Waypoint** and press **ENTER**. Or, highlight the first blank line and press **ENTER**.
5. The Aviation Find page (Go To page) opens allowing you to select an aviation point. Enter the ID, Facility name, or city.

6. Highlight the desired point in the list. Highlight **OK** and press **ENTER**. The selected point is added to the route.

Highlight a blank line and press **ENTER** to continue adding waypoints.



One leg added to the route

7. Continue steps 4 through 6 until all points are added to the route. The route is automatically saved to the unit's memory.

To navigate a saved route:

1. Press **MENU** two times to open the Main Menu.
2. Use the **Rocker** key to highlight **Routes** and press **ENTER**.
3. Highlight the route you want to take from the list and press **MENU**.
4. Highlight **Activate Route** and press **ENTER**.

You can also create a flight plan to use at a later time. For more information, refer to “[Creating Routes](#)” beginning on page 55 and “[Editing and Managing Routes](#)” beginning on page 68.

Following your Flight Plan

Once you have created and activated your flight plan (or route), the GPSMAP 296 guides you to the destination using a variety of tools.

Track Your Progress on the Map page

On the Map page, your current position is shown as an airplane (when in Aviation Mode). You can see how the airplane moves across the map; this is a graphic view of your flight. Your route is marked with a magenta line. The airplane should be on top of the magenta line as you move. When you are on the magenta line, you are directly on course.



NOTE: *In Aviation (and Marine) Mode, the Go To line and navigation guidance are fixed. The From point is the position where the Go To was initiated. In Automotive Mode, the Go To line on the map is constantly updated to your present position.*

For complete information about the Map page and the features of the Map page, see “[Map Page](#),” beginning on page 29.

Watch for Terrain and Obstacles Changes

Press **PAGE** to open the Terrain page, and watch the changes in the terrain and the obstacles you are flying over with the Terrain page. Terrain and obstacles that are less than 100 feet from your aircraft are shown in red. For complete information, see page 35.

View the HSI on the Panel Page

You can use the Panel page to view the HSI, your bearing to the course, and other information such as speed, altitude, and ETA.

Use the compass in the center of the page to determine if you are on the proper course. Also, you can help keep the aircraft within the VNAV profile when viewing the VNAV indicator.

For complete information about the Panel page, see the section “[Panel Page](#),” beginning on page 38.

Watch the Pop-up Alerts

As you travel, you may see a variety of alerts pop up on your current page, such as Airspace, Terrain, Obstacle, and Descent Rate Alerts.

When an Airspace Alert pops up, press **NEAREST** to view the Airspace Information.

When a Terrain or Obstacle alert pops up, press the **PAGE** key to open the Terrain page. From here you can view any terrain and obstacles that might become a problem to you. Possible points-of-impact are displayed as Xs. Adjust your altitude to avoid the obstacles and terrain.





WARNING: *There are NO audible alarms with Terrain, Obstacle, and Descent Rate Alerts.*

AVIATION MODE PAGES AND FEATURES

This section discusses the major pages, such as the Map and Terrain pages, as well as some additional aviation features, such as E6B.

Map Page

The GPSMAP 296 features a real-time moving map that can do much more than just plot your course. The Map page displays map information (digital cartography) that includes airspace boundaries, airports, nav aids, lakes, rivers, coastlines, cities, and highways. Dedicated zoom keys (**IN** and **OUT**) are provided for scale adjustments.

Two basic map operating modes, position mode and pan mode, determine what cartography is shown on the map display. Position mode pans the map to keep your present position in the display area. The position marker (icon) that shows your travel on the Map page is an aircraft symbol  in Aviation Mode and a triangle symbol  in Marine and Automotive modes. The GPSMAP 296 always powers up in position mode, with the last known location centered on the map. When you press the **Rocker** key, the GPSMAP 296 enters pan mode, which moves the map to keep the white arrow  (map pointer) within the display area.

In Aviation Mode, by default, four user-selectable data fields appear in the corners of the screen that can be configured to display any one of the several data options. You can also change the layout of the map and data fields: see page 105 for information.

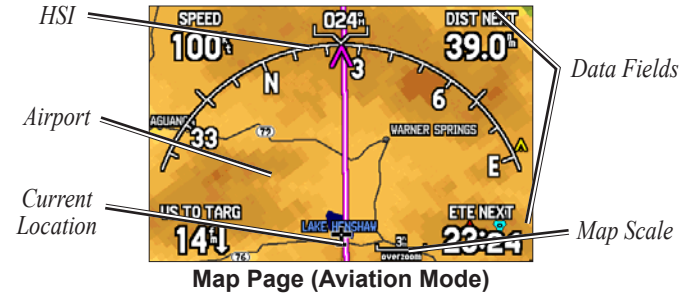

A navigation arc (Horizontal Situation Indicator, or HSI) appears by default on the Map page. The arc works like the compass on the Panel page, indicating the desired course and your deviation left/right of this course. If the route line and pink arrow are heading straight up, you are heading directly to your destination.

Map Orientation

There are two map orientation options: North Up orients the map like a paper map, while Track Up orients the map in the direction of travel. When using Track Up, the North arrow indicates the orientation. To change the map orientation, press **MENU** to open the Map page. Press **MENU**. Select **Set Up Map** and press **ENTER**. Refer to page 34 for information.

Zooming In and Out of the Map

The map display has 28 available range scales from 20 ft to 800 nm (20 ft to 800 mi or 5 m to 1200 km). The map scale is controlled by the **IN** and **OUT** keys, with the current scale displayed at the bottom right of the data window.



NOTE: The scale value represents the distance from ends of the scale bar (20 **3m**).

To select a map scale (zoom in and out):

- Press the **OUT** key to zoom out.
- Press the **IN** key to zoom in.

The system has a built-in worldwide database to 20 mile zoom scale, with more detailed coverage available through the use of the Jeppesen, BlueChart, or MapSource data. The GPSMAP 296 displays cartography as long as there is chart information available for the range you have selected.

Map coverage conforms to the following conditions:

- Cartography is displayed when the selected zoom range is covered by either the internal basemap or other MapSource data loaded onto a data card.
- When the selected zoom range is covered by both the internal database and data card map information, the cartography with the best resolution is displayed.
- When the selected zoom range exceeds the resolution of the data in use, “overzoom” appears below the map scale.

20
overzoom



No additional data is available

- When external data (such as MapSource data) is used, “map card” appears below the map scale.

20
map card

Using detailed maps loaded on the data card

Panning the Map

The panning arrow  allows you to pan the map to show other map areas. As you pan past the edge of the current map display, the screen moves to provide continuous map coverage. The position icon  stays in your present location and may not be visible on the display screen when you pan the map.

To pan the map:

Press Up, Down, Right, or Left on the **Rocker** key.

The panning arrow moves the map so you can view different parts of the map.

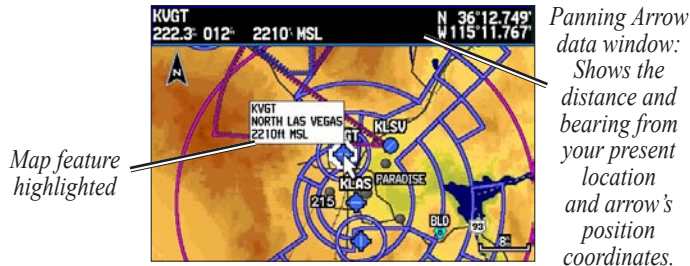

Panning the Map

As you move the arrow, the distance and bearing from your present position to the arrow is displayed in the data window, along with the arrow's position coordinates. When you zoom in pan mode, the arrow stays centered on the screen. When the arrow is stationary, fixed coordinates appear in the position field, and the distance and bearing from your present position update as you move.

To re-center your position on screen:

When you are finished panning the Map, press **QUIT**.

The map automatically moves to show your present location, and the unit returns to position mode.

The arrow may also be used to select on-screen map items, allowing you to review a selected item directly from the map display.

To view details about an on-screen point:

1. Use the **Rocker** key to move the arrow to the desired waypoint or map item. If there are several items grouped closely together, zoom in closer for a better view.

When a waypoint or map item is selected, it is highlighted on screen with the name and position displayed at the top of the screen, along with the distance and bearing from your current location, as shown in the image to the right.

2. Press **ENTER** to view more information about the point. The information and on-screen buttons displayed vary depending on the type of item selected. In some cases, additional information tabs appear at the top of the Information page or Waypoint page.
3. If desired, use the **Rocker** key to highlight the extra tabs and view the information.
4. Select an on-screen button and press **ENTER**. Press **QUIT** to exit the information page.



Airport Information Page

Airspace Information

Pan mode may also be used to retrieve information on airspaces depicted on the map.

*Highlighted
airspace area*



Airspace Information

*Information
box with
airspace name,
type, and floor/
ceiling limits*

To retrieve airspace information from the Map page:

1. Use the **Rocker** key to select an area within the desired airspace boundary. The boundary line is highlighted and the airspace type and floor/ceiling limits are displayed.
2. To display additional information press **ENTER**.
View communication frequencies by highlighting the on-screen **Frequencies** button and pressing **ENTER**. You can also use the **Rocker** key to highlight the **Comm** tab.
3. To return to the Map page, highlight **OK** and press **ENTER**.

Clearing Unwanted Details from the Map

You can remove items from the Map page display (declutter the display) to remove unwanted items, such as highways. Aviation Mode has various levels of declutter.

To quickly declutter the map, press **ENTER**. You can also declutter the map on the Terrain page.

To declutter the Map page:

1. From the Map page, press **ENTER**. **Clear-1** appears under the map scale. The background map detail—including highways, cities, rivers & smaller lakes—is removed from the map display.
2. Press **ENTER** again. Airspace boundary detail is removed from the map display. **Clear-2** appears below the map scale.
3. Press **ENTER** again. Only the waypoints and nav aids that are part of the current Go To or route appear on the map display. **Clear-3** appears below the map scale.
4. In Aviation Mode, press **ENTER** again to return ALL detail to the map display.

In Marine and Automotive, press **MENU**, highlight **Declutter Off**, and press **ENTER**.

Measuring Distance

You can measure the distance and bearing between two map items.

To measure the bearing/distance between two points:

1. From the Map page, press **MENU** to open the options menu.
2. Highlight the **Measure Distance** option and press **ENTER**. An on-screen arrow appears on the map display at your present position with **ENT REF** below it.
3. Move the arrow to the desired reference point (the starting point that you want to measure from) and press **ENTER**. A push-pin icon marks the starting point on the map display.

Push pin indicating the beginning point of the measurement



End point of measurement, labeled "ENT REF"

Measure Distance

4. Move the arrow to the point want to measure to. The bearing and distance from the reference point and arrow coordinates are displayed in the data window at the top of the display.
5. Press **QUIT** to finish.

Setting the Bug Indicator

You can set a bug indicator to show your bearing or your course to steer. You can also enter a specific heading reference for the indicator.

To set the Bug Indicator:

1. From the Map page, press **MENU** to open the options menu.
2. Use the **Rocker** key to highlight **Set Bug Indicator** and press **ENTER**.
3. A list of Bug Indicator options appears. By default, the bug indicator shows **Bearing** (BRG) to waypoint, but can also show the **Course to Steer** (CTS) or can be **User Selected**. The **User Selected** option allows you to mark a heading reference on the graphic HSI. This provides a visual cue of an important heading for current or future use. You can also turn the Bug Indicator off here.
4. Highlight the desired option from the list and press **ENTER**.

You can also set the Bug Indicator on the HSI displayed on the Panel page. Open the Panel Page and press **MENU**. Follow steps 2 through 4 above.

Setting up the Map page

The Map page Setup allows you to adjust the way items are displayed on the Map page.

To change a map setup option:

1. From the Map page, press **MENU** to open the options menu.
2. Highlight **Set Up Map**, and press **ENTER**.
3. Press Left or Right on the **Rocker** key to highlight the desired file tab, then Up or Down on the **Rocker** key to highlight to the field you want to change and press **ENTER**.



General Tab of the Map Page Setup

4. Press Up or Down on the **Rocker** key to highlight to the desired setting and press **ENTER** to select the new setting.
5. Press **PAGE** or **QUIT** to exit.

Terrain Page

The Terrain page, available only in Aviation Mode, provides an overhead view of the terrain and obstacles beneath you. Alert windows pop up on all pages to inform you of your proximity to the terrain and obstacles, as well as a quick descent rate. These alerts depend upon user-defined parameters in the Terrain setup.

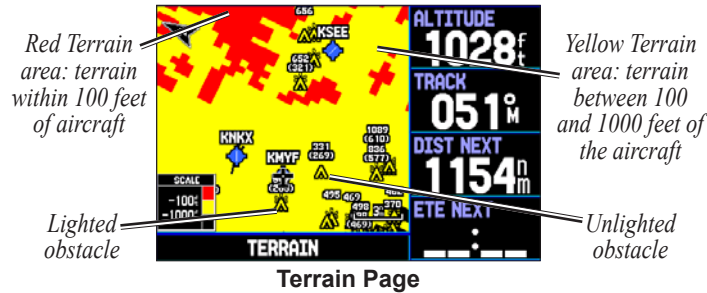

Terrain Page





Terrain Information

The areas of the terrain shaded red are predicted to be within 100 feet above or below the aircraft. The yellow terrain areas are between the user-defined **Caution Elevation** and 100 feet below the aircraft. By default, the **Caution Elevation** is 1000 feet; therefore, the areas in yellow are between 1000 feet and 100 feet below the aircraft. The black areas are further than the **Caution Elevation**. A projected point of impact is marked with an “X” symbol.

Obstacle Information

Obstacles are always displayed on the Terrain page regardless of the map scale and are displayed on the Map page when the map scale is set to 3 nm or below.

Standard aeronautical chart symbols are used for lighted or unlighted obstacles taller than 200 feet Above Ground Level (AGL). Refer to the Obstacle Icons legend below.

-  Lighted Obstacle 1000 ft AGL and higher.
-  Unlighted Obstacle 1000 ft AGL and higher.
-  Lighted Obstacle below 1000 ft AGL.
-  Unlighted Obstacle below 1000 ft AGL.

Obstacle Icons

Each obstacle is labeled with the altitude of the top of the obstacle, or Mean Sea Level (MSL). Each obstacle also lists, in parentheses, the actual height of the obstacle, or Above Ground Level (AGL).

Terrain and Obstacle Color Code

Red: Terrain or obstacle is within 100 feet of the aircraft.

Yellow: Terrain or obstacle is between the user-defined **Caution Elevation** and 100 feet below the aircraft.

Pop-up Alerts

If you are on another page of the GPSMAP 296 unit, pop-up Terrain, Obstacle, and Descent Rate Alerts display in the lower left-hand corner to inform you of the situation. The alert remains on the screen until the flight path has cleared the obstacle or terrain, or until you have pressed **ENTER**.



Pop-up Terrain Warning

Shown on the Panel page



NOTE: There are NO audible alarms with Terrain, Obstacle, and Descent Rate Alerts.

Additional Terrain Page Options

Access the Terrain page options menu by pressing **MENU** while you are on the Terrain page.

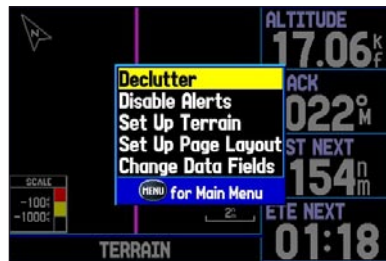

Terrain Page Options Menu

- Press **ENTER** to quickly declutter the map, just as you would on the Map page. See page 33.
- To quickly disable alerts, highlight **Disable Alerts** and press **ENTER**. Repeat to enable alerts again.
- You can pan the map and zoom in and out using the same techniques you use on the Map page. See page 31.
- You can change the layout of the Terrain page. Refer to page 105. Also, refer to the “Appendix,” page 145, for information about the data fields.

Setting up the Terrain Page and Alerts

The Terrain Setup page allows you to set levels for terrain alerts as well as obstacles in or near your flight path.

Caution Elevation

Select the desired **Caution Elevation**. If the terrain or an obstacle is within the **Caution Elevation** you entered, the GPSMAP 296 provides an alert.

Look Ahead Time

The **Look Ahead Time** for Terrain and Obstacle Alerts determines the time when an alert annunciation (a pop-up window) occurs. For example, if 120 seconds is selected, the GPSMAP 296 will provide an alert 120 seconds before you reach the terrain or obstacle.

Alert Sensitivity

The three Alert Sensitivity settings (**Terrain**, **Obstacle**, and **Descent Rate**) determines what level of alerts are annunciated. The GPSMAP 296 defaults to **High** sensitivity, which annunciates all red and yellow alerts at the time set in **Look Ahead Time**. **Medium** sensitivity annunciates all of the red and the highest priority of yellow alerts, and **Low** only annunciates red alerts.

To set up the Terrain page:

1. On the Terrain page, press **MENU** to access the Terrain page options menu.
2. Select **Set Up Terrain** and press **ENTER**.



Terrain Setup Page

3. Make the desired adjustments to the Terrain Setup Use the **Rocker** key to select options and press **ENTER**. Select the desired option and press **ENTER**.
4. Press **PAGE** or **QUIT** to accept the changes and exit the Set Up Terrain page.

Panel Page

The Panel page displays GPS-derived data in a graphical format, similar to an instrument panel. Keep in mind the differences between this page and your mechanical instruments, as your mechanical panel instruments use sensors that provide information different from that derived using GPS. The Panel page appears only when the GPSMAP 296 is in Aviation Mode.

The Panel page displays a graphic Horizontal Situation Indicator (HSI) surrounded by additional indicators.

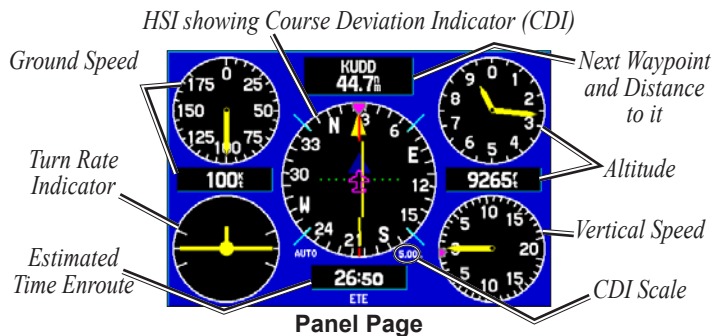

The graphic HSI depicts the desired course to the destination or the next waypoint in a route, current ground track, off course error, and a To/From indication. The rotating compass indicates your current ground track at the top of the page.

The desired course pointer and course deviation needle indicate the desired course and whether you are on the desired course. A bug indicator provides information to guide you back to the desired course if you stray off course.

If you move off course, the Course Deviation Indicator, or needle, indicates how far off course you are, left or right, based upon its placement along the course deviation scale. To get back on course and center the needle, simply steer toward the needle.

The course deviation scale setting is adjustable for ± 0.25 , 1.25 or 5.0 (nautical mile, statute mile, or kilometer) full-scale deflection. The default setting is **1.25**, which represents the distance from the center of the CDI to full left or right limits. The course deviation scale appears on the lower right corner of the HSI.

Setting up the Panel page

You can set the bug indicator and change the CDI scale to suit your needs.

To set a user-defined bug heading reference:

1. With the Panel page displayed, press **MENU** to display the Panel page options menu.
2. Highlight **Set Bug Indicator** and press **ENTER**.
3. Highlight **User Selected** and press **ENTER**. A window appears at the center of the HSI, showing the current bug indicator setting.
4. Select the desired heading reference by pressing Left or Right on the **Rocker** key. Press **ENTER**. The bug indicator remains fixed on the selected heading until a new bug heading is chosen.

To change the CDI scale:

1. With the Panel page displayed, press **MENU** to display the Panel page options menu.
2. Use the **Rocker** key to highlight **Set CDI Scale** and press **ENTER**. A window appears at the center of the HSI, showing the scale settings. The current setting is highlighted.
3. Use the **Rocker** key to select the desired scale and press **ENTER**.

Manually Setting a Course

Use the **Set OBS and Hold** option to manually set your course to the destination.

To manually set a course to the destination waypoint:

1. With the Panel page displayed, press **MENU** to display the Panel page options menu.
2. Highlight **Set OBS and Hold** option and press **ENTER**. An OBS data field appears on the display. Keep in mind that you must have a destination waypoint selected.
3. Select the desired OBS course by pressing the **Rocker** key Left and Right. Press **ENTER**. The course deviation needle and desired course pointer now provide steering guidance to the selected course.

To release the waypoint hold and return to automatic sequencing of route waypoints, press **MENU**. Highlight **Release Hold** and press **ENTER**.

To cancel the OBS course and reset a direct course to the waypoint, press **Direct To**, highlight **Resume Route**, and press **ENTER** to re-activate the route.

VNAV (Vertical Navigation)

The VNAV tab in the Main Menu provides settings for the vertical navigation feature. These settings create a three-dimensional profile that guides you from your present position and altitude to a final (target) altitude at a specified location.

Once the VNAV profile is defined, message alerts help keep you informed of your progress. The teal bar on the HSI on the Panel page displays your VNAV profile.

To use the vertical navigation feature, your ground speed must be greater than 35 knots and you must be navigating a Go To or a route.

The “Approaching VNAV Profile” message appears one minute prior to the initial descent point. The descent angle locks to prevent changes in speed from altering the profile. The VNAV feature does not take into account any changes in groundspeed that occur during the transition from level flight to descent or climb.

At 500 ft above the target altitude, the “Approaching Target Altitude” message appears, the time to vertical navigation goes blank, and the VNAV indicator disappears from the Panel page.



NOTE: *The GPSMAP 296 is a VFR navigation tool and should not be used to perform instrument approaches. VNAV is only a VFR navigation instrument and is not intended for instrument approaches.*

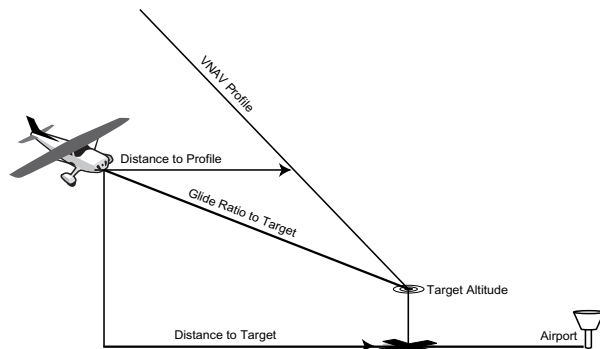

Visual representation of VNAV

Using the VNAV Feature

Use the VNAV (Vertical Navigation) feature to ensure that you are flying at the proper altitude. The VNAV Indicator appears on the HSI (Panel page) as a horizontal teal bar, as shown in the image on the next page. A pop-up message appears when you are approaching the VNAV Profile. When the bar is in the vertical center of the HSI, you are at the proper altitude for the VNAV Profile. Make sure **VNAV Indicator** is **On** in the options menu.

From the Panel page, press **MENU** to open the options menu. Select **Capture VNAV Profile** and press **ENTER** to center or re-center the VNAV indicator on the graphic HSI. You must have entered a valid vertical navigation profile and be navigating.



Panel Page showing the VNAV Indicator

Setting up VNAV

To open the VNAV tab, press **MENU** twice to open the Main Menu. Select **Setup** from the vertical tab list. Then select **VNAV** from the row of tabs along the top of the page.

Target Altitude—enter the altitude you want to be at when you reach your target location. Select **Above Waypoint** to use field elevation for airports in the Jeppesen database or **Above MSL** to specify an exact MSL altitude target.

The VNAV Waypoint automatically changes to your destination after you begin navigating to a destination.



VNAV Setup Tab

By—defines the target location with settings of distance **Before** or **After** a reference waypoint (the final destination airport). To set a target location at a reference waypoint, enter a distance of zero.

VNAV Waypoint—allows you to select any waypoint along the currently active route (or Go To) as your reference waypoint. The reference waypoint defines the target location.

VNAV Profile—allows you to select the desired descent rate.

VNAV Messages—enables and disables VNAV alert messages.

Active Route Page

Whenever you activate a route (flight plan) or initiate a Go To while in Aviation or Marine Mode, the Active Route page shows each point (waypoint or map item) of the active route, with the point name, Course, Distance, and several other fields of information. The current destination point, the active point, is marked with an arrow. As you navigate a route, the list automatically updates to indicate the active point first. The Active Route and Route Review Pages share many of the same features and options.

Press **PAGE** repeatedly to open the Active Route page.

Active Route			
KRNM-KVGT			
Waypoint	Course	Distance	ETA
↖ KRNM	024M	---	---
↙ KUDD	036M	46.8M	09:34M
↘ TNP	030M	80.1M	09:54M
▣ 0004	006M	98.6M	10:05M
↘ GFS	350M	149M	10:36M
↙ JAKOP		211M	11:13M
Total	011M	216M	11:16M

Active Route Page

Active Route Page Options

Press **MENU** while on the Active Route page to open the options menu. You can edit the route using many of the options in the menu such as **Edit on Map** (see page 71 for information), **Add Waypoint**, and **Invert**. You can also change the data fields to suit your needs.

You can also select an approach for your landing and set your fuel flow (or plan your route, depending upon your current Usage Mode):

Select Approach—(Aviation Only) allows you to select the final course segment of a published approach, replacing the final destination airport in a Go To or route with the sequence of waypoints for the selected approach. The approaches provide only the final course segment, usually from final approach fix (FAF) to missed approach point (MAP), and are based on existing GPS, RNAV, VOR, NDB, localizer, or ILS approach procedures. All approach procedures are flown as a sequence of waypoints in the route. To select an approach and add the waypoints to the route, the final destination in the Go To or route must be an airport with a published approach. Refer to page 23.

Set Fuel Flow (Plan Route)—allows you to enter information about your aircraft and route.

Position Data Page

The Position Data page provides a quick reference for the important data you want to display while navigating a route in Aviation Mode and Marine Mode. The default page displays a compass ribbon, your current latitude and longitude, the current date and time, the location you are traveling from, and eight user-selectable data fields. The compass ribbon is displayed at the top of the page to show your current heading with a red, vertical bar. To stay on course, steer towards the violet bar (or arrows) until it is aligned with the red bar.

Press **PAGE** repeatedly to open the Position Data page.

Position Data Page

I 015	030	NE	NEXT WPT KUDD	ETE NEXT 28:31
N 33°07.210'	W 116°51.133'		SPEED 100k	ALTITUDE 8035ft
09:05:51 ^A _M	01-NOV-04		FUEL TIMER 00:00	FLT TIMER 00:00
From Ramona (KRNM):			SUNRISE 08:05^A_M	SUNSET 06:56^P_M
5.8%	020M		BATTERY 00:00	POWER

Airport is selected as the Nearest Type. The Romona (KRNM) airport is the nearest airport.

Position Data Page Options

With the Position Data page open, press **MENU** to open the options menu. You can set up the layout of the page and change the data fields. For an explanation of the data fields, refer to page 145 in the “Appendix.” You can also select one of the following options:

Change Nearest Type—allows you to specify the type of item to be used as the nearest item (displayed in the lower-left data field). The choices differ based upon the Usage Mode you are currently using.

Reset Trip—clears trip information, except the maximum speed and the odometer.

Reset Max Speed—clears the maximum speed.

Reset Odometer—clears the running total of the distance traveled since the odometer was last reset.

Reset All—clears all trip information including the maximum speed and odometer.

Flight Log

The Flights tab displays a list of any recorded flights, including date, route of flight, and flight time. The GPSMAP 296 saves up to 50 recorded flights while in Aviation Mode. Entries on this list are automatically created for each flight.

The bottom of the Flights tab displays the time of your last flight. This will reset if you select **All Unit Defaults** from the System tab options menu.

An optional FlightBook software package is available to further simplify your flight record keeping. For details about FlightBook, visit the Garmin Web site at <http://www.garmin.com/aviation>.

Viewing the Flight Log

Recording begins when your speed exceeds 30 knots and you gain 500 feet of altitude. The **Route of Flight** field uses the nearest airport as the departure airport. The destination airport is continuously updated as your flight progresses.

If you land and groundspeed drops below 30 knots, the flight entry is saved and a new entry will be recorded when you depart the airport. A touch-and-go or brief stop of less than ten minutes appends to the current flight record, rather than starting a new entry.

Select any listed entry in the log to view additional information.

To view details for a flight:

1. Press **MENU** twice to open the Main Menu.
2. Highlight **Flights** from the vertical menu of tabs.
3. Press **MENU** and select **Show Hours and Minutes** to view the flights in minutes and hours, if you prefer.
4. Highlight the desired flight and press **ENTER**. The flight details window opens, shown below.
5. With **OK** highlighted, press **ENTER** to return to the Flights tab.

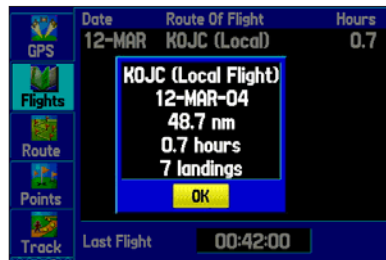

Flight Tab

Displaying the flight details page

Deleting Flight Records

You can delete the highlighted flight record (**Delete Flight**) or delete all flight records from the Flight Log (**Delete All**). To delete flights, press **MENU** (with the Flights tab information displayed). Use the **Rocker** key to highlight the desired option and press **ENTER**.

Aircraft Information

The Aircraft tab is divided into two separate tabs: Aircraft Profile and Weight & Balance.

To open the Aircraft tab of the Main Menu:

1. Press **Menu** twice to open the Main Menu.
2. Highlight **Aircraft** from the vertical list of tabs.
3. Press the **Rocker** key Right or Left to highlight either the **Aircraft Profile** tab or the **Weight & Balance** tab from the top of the screen.



Aircraft Profile Tab

Entering Your Aircraft Profile

The Aircraft Profile tab allows you to define cruising speed, maximum speed, and fuel flow for up to ten aircraft that you regularly fly.

Cruising speed and fuel flow are used as default settings when viewing trip planning information on the Route Review page. The maximum speed is used to define the range for airspeed on the Panel page and is automatically updated if you exceed this figure.

To enter an aircraft profile:

1. From the Aircraft Profile tab, use the **Rocker** key to highlight the on-screen **New** button and press **ENTER**.
2. Highlight the **Current Aircraft** field and press **ENTER**. Or, highlight the **Rename** button and press **ENTER**.
3. Use the **Rocker** key to **ENTER** the aircraft tail number (or other identifying information) in the **Current Aircraft** field. Press **ENTER** when finished.
4. Use the **Rocker** key to enter information for the cruising and maximum speeds for your aircraft, your aircraft's fuel flow, and the symbol for your aircraft.

Select a symbol for your aircraft to change the data fields on the Panel page to best suit the type of aircraft you are flying.

To select a saved aircraft profile:

1. From the Aircraft Profile tab, use the **Rocker** key to highlight the **Current Aircraft** field and press **ENTER**.
2. Use the **Rocker** key to select the desired aircraft profile and press **ENTER**.

To rename or delete a saved aircraft profile:

1. From the Aircraft Profile tab, use the **Rocker** key to highlight the **Current Aircraft** field and press **ENTER**.
2. Use the **Rocker** key to select the on-screen **Rename** or **Delete** button and press **ENTER**. If **Rename** is selected, use the **Rocker** key and **ENTER** to enter a new tail number.

Calculating the Weight & Balance

Weight & Balance may be used during your pre-flight preparations to verify the weight and balance conditions for your aircraft. By entering the weight and arm values on this page, the GPSMAP 296 can calculate the total weight, moment, and center of gravity (CG) to ensure a safe flight.

Before entering the various figures, you need to determine the empty weight of the airplane and the arm (or “station”) for each weight entered. These figures should be determined using the pilot’s operating handbook for your airplane, which will also note the weight limitations and fore/aft CG limits. Compare those figures to the values calculated by the GPSMAP 296.

To perform weight and balance calculations:

1. Press **MENU** twice to open the Main Menu.
2. Highlight **Aircraft** from the vertical list of tabs.
3. Press the **Rocker** key Right to highlight **Weight & Balance**.

Aircraft Profile		Weight & Balance	
ITEM	WEIGHT	ARM	
Aircraft	0 lbs	0.000	
Usable Fuel	0 lbs	0.000	
Pilot	0 lbs	0.000	
Co-pilot	0 lbs	0.000	
Passenger	0 lbs	0.000	
Passenger	0 lbs	0.000	
Baggage	0 lbs	0.000	
Other	0 lbs	0.000	
MOMENT		C.G.	
0	0 lbs		

Weight & Balance Tab

4. Highlight the desired weight field and press **ENTER**.
5. Use the **Rocker** key to enter the weight figure. Press **ENTER** when finished.
6. Change the weight units, if desired. Highlight **lbs** and press **ENTER**. Select **Kgs** and press **ENTER**.
7. Highlight the corresponding arm field and press **ENTER**.
8. Use the **Rocker** key to enter the arm figure. Press **ENTER** when finished.
9. Repeat steps 4 through 8 until all figures are entered. The calculated moment, weight, and CG figures appear at the bottom of the page. Keep in mind that the “Aircraft” (empty weight/arm) figures must be entered as a reference to calculate a valid moment, weight, and CG.

To empty the aircraft, press **MENU** and press **ENTER**.

E6B Tab

The E6B tab in the Main Menu calculates Density Altitude, True Airspeed, and Winds Aloft (Head Wind, Tail Wind, Wind From, and Wind Speed), based upon information you enter.

To open the E6B tab of the Main Menu:

1. Press **MENU** twice to open the Main Menu.
2. Highlight **E6B** from the vertical list of tabs.

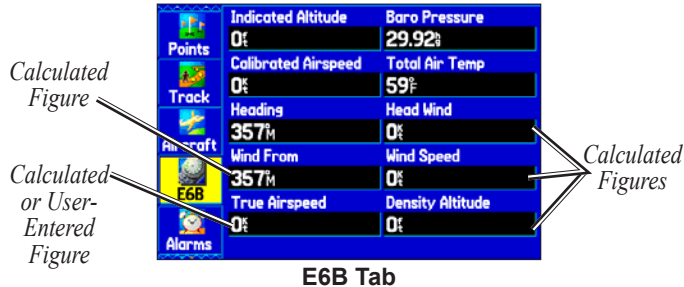

Indicated Altitude—required entry for density altitude/true airspeed calculation. Enter the aircraft’s altimeter reading.

Calibrated Airspeed—required entry for density altitude/true airspeed calculation. Enter the aircraft’s airspeed indicator.

Heading—required entry for winds aloft calculation. Use heading from the aircraft’s heading indicator or directional gyro.

Baro Pressure—required entry for density altitude/true airspeed calculation. Use current altimeter setting (barometric pressure).

Total Air Temperature—required entry for density altitude/true airspeed calculation. Total Air Temperature (TAT) is the temperature of the air including the heating effect caused by speed. The temperature reading on a standard outside air temperature gauge found on most piston aircraft is TAT.

Head Wind—(calculated figure) determined from entry of heading and true airspeed.

Wind From—(calculated figure) determined from entry of heading and true airspeed.

Wind Speed—(calculated figure) determined from entry of heading and true airspeed.

True Airspeed—(calculated or user-entered figure) determined from entry of calibrated airspeed, baro pressure, and total air temperature. Also can be entered directly for winds aloft calculations.

Density Altitude—(calculated figure) determined from entry of indicated altitude, baro pressure and total air temperature.

To calculate true airspeed and density altitude:

1. From the **E6B** tab, highlight the **Indicated Altitude** field (at the top of the page) and press **ENTER** .
2. Use the **Rocker** key to enter the altitude displayed on your altimeter. Press **ENTER** when finished.
3. Repeat steps 1 and 2 to enter the **Calibrated Airspeed**, **Baro Pressure**, and **Total Air Temperature**. (For **Calibrated Airspeed**, use the speed displayed on your airspeed indicator. Use the current altimeter setting for **Baro Pressure**. **Total Air Temperature** is the temperature of the outside air including the heating effect caused by speed. For most aircraft, this is the temperature reading on a standard outside air temperature gauge.)
4. The calculated figures for **True Airspeed** and **Density Altitude** are displayed in the designated fields.

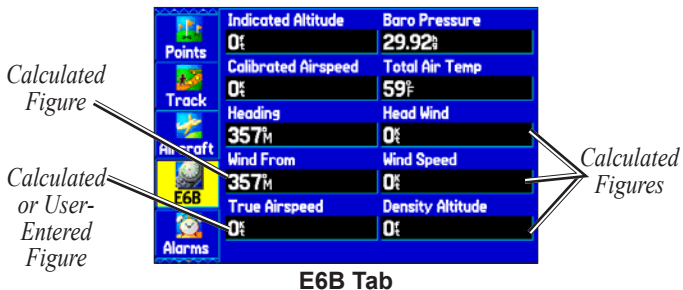

To calculate winds aloft:

1. Follow the steps in the previous procedure to determine true airspeed. Or, use the **Rocker** key and **ENTER** to manually enter a true airspeed figure in the True Airspeed field.
2. Use the **Rocker** key to highlight the Heading field and press **ENTER** .
3. Use the **Rocker** key to enter the aircraft heading displayed on your directional gyro or compass. Press **ENTER** when finished.

The calculated figures for Head Wind, Wind From, and Wind Speed are displayed.



***NOTE:** If a True North reference is currently selected as the heading reference on your GPSMAP 296, you must enter Heading using a True North reference to determine winds accurately.*

To restore defaults on the E6B tab:

1. Open the E6B tab of the Main Menu.
2. Press **MENU** to open the options menu.
3. Highlight **Restore Default** and press **ENTER**.

BASIC OPERATION IN AUTOMOTIVE MODE

This section explains some of the more common Automotive operations you will perform with your GPSMAP 296, such as creating routes and waypoints.

To switch usage modes:

1. Press and hold the **PAGE** button.
2. Use the **Rocker** key to select either Aviation, Automotive, or Marine and press **ENTER**.

Automotive Mode Page Sequence

Automotive Mode features two main pages: the Map and Trip Computer pages. Optional Highway and Compass pages may be enabled in Automotive Mode. Two additional pages appear during active navigation while in Automotive Mode—a Current Route page appears if you are navigating a turn-by-turn route, and an Active Route page appears if you are navigating “Off Road.” See “[Navigating in Automotive Mode](#)” beginning on the next page for more information.





To add the Compass page or Highway page:

1. Press **MENU** twice to display the Main Menu. Use the **Rocker** key to highlight the **Display** tab.
2. Highlight the **Highway page** or **Compass page** field and press **ENTER**. Select **On** and press **ENTER**.

Navigating in Automotive Mode

Automotive Mode and Marine Mode are very similar. Most of the features discussed here also apply to Marine Mode.

There are several ways to begin navigating to a point in Automotive Mode:

- Select a point on the map and press the **Direct To**  key.
- Press the **Direct To**  key to activate a new route using the Find menu, or activate a saved route or track.
- Press the **FIND** key to search for a particular item and create a route to it.

You can also activate a saved route through the Routes tab of the Main Menu. For information, refer to page 69.

To go to a highlighted map item:

1. Use the **Rocker** key to highlight the item you would like to navigate to on the Map page.
2. Press **Direct To** . **Go To <point name>** is added to the list of options and automatically highlighted. If you have selected an area of the map that is not a map feature, **Go To MAP Point** is listed. Select **Go To <point name>** or **Go To MAP Point** and press **ENTER**.

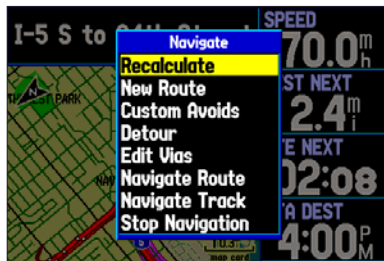

Navigate Options in Automotive Mode

With Map Feature highlighted while navigating a course

3. Follow the magenta route created on the Map page. Follow the turn-by-turn route (auto-route) by using the Next Turns page and Current Route page. If you are using the external speaker, follow the voice prompts.

To activate new route using the Find Menu:

1. Press the **Direct To** \blacktriangleright key to open the Navigate menu.
2. Highlight **New Route** (or **Go To Point** when in Marine Mode) and press **ENTER** to open the Find Menu.
3. From the Find Menu, highlight **Waypoints** and press **ENTER**. (You may also choose to go to other points, such as **Cities** or **Tide Stations** from this list. The steps vary only slightly from those listed for **Waypoints**.)
4. Select a waypoint from the list then press **ENTER** to display the Waypoint page.

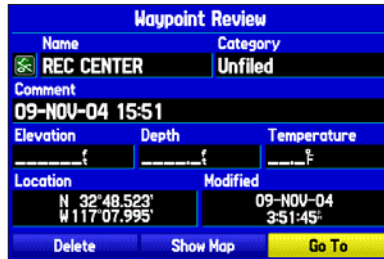
**Waypoint Page**

Activating a Go To using the Find Menu

5. The Waypoint page automatically opens. With the **Go To** button highlighted, press **ENTER** to begin navigation.

To search for an item and route to it:

1. Press the **NRST/FIND** key to open the Find Menu.
2. Using the **Rocker** key, highlight the desired category, such as **Cities**, and press **ENTER**.
3. Press **ENTER** and use the **Rocker** key to begin entering the letters contained in the item name. The list begins to sort by the items that contain the letters you are entering. Press **ENTER** when finished.



Finding an item using the Containing field: The unit searches for items containing the letter combination you enter and displays them in the list.

4. Highlight the desired item from the list and press **ENTER**.
5. Highlight the **Go To** button and press **ENTER**.

For complete information about finding an item, refer to the following section.

Finding an Item

The Find Menu allows you to easily search the stored waypoints and points of interest. You can access the Find Menu by pressing the **NRST/FIND** key.

The Find Menu is comprised of several default categories: Waypoints, Cities, Exits, Aviation Points, Transportation, and Tide Stations. Additional categories are displayed depending on the optional BlueChart or MapSource data card in the unit.



Find Menu

Shown without additional BlueChart or MapSource maps installed

Follow the directions on the previous page to search for an item near your current location and then route to it.

Using the Find From Feature

The Find option also supports a “find from” feature that allows you to center your search around an item that you have just found.

To find an item from another location on the map:

- 1 Open the Map page. Use the **Rocker** key to pan the arrow (pointer) to the desired location and press **NRST/FIND**.



Find From Map Pointer

2. The Find Menu opens displaying “From Map Pointer.” The list of items is sorted to display items nearest the selected location. Using the **Rocker** key, highlight the desired category from the list and press **ENTER**.
3. Using the **Rocker** key, highlight the desired item from the list and press **ENTER**. The item’s information page automatically opens, allowing you to save the item as a waypoint, show the item on the map, or automatically create a route to (Go To) the item.

To find an item from another location:

1. From any page, press the **NRST/FIND** key.
2. Using the **Rocker** key, highlight the desired category from the list and press **ENTER**.
3. Press **MENU**. Highlight **Near Other** and press **ENTER**. If you are actively following a route, you may also choose one of the other options listed in the Find From list, as shown below.

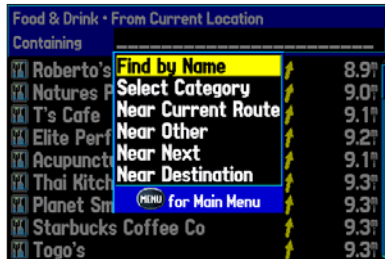
**Find From options**

4. Select a reference position on the map and press **ENTER**. The list displays items near the new map position.

To find an item near another item:

1. Press the **NRST/FIND** key.
2. From the Find Menu, highlight the item you want to Find From, such as Coronado, CA.

3. Press **NRST/FIND** with the item highlighted. The Find Menu opens again with items near the previously selected item, Coronado, CA in this example. Search for the desired item.

Recently Found Items

The Recently Found page displays a list of the items you have searched for or gone to recently.

To view recently found items:

1. Press the **NRST/FIND** key. The Find Menu opens.
2. Use the **Rocker** key to highlight **Recently Found**. Press **ENTER**. The Recently Found page opens.

Press **MENU** to display the options menu:

Show Find History—allows you to toggle between displaying the items you have searched for recently (Find History) and the items you have recently created a Go To for (Go To History).

Remove Point—removes the point that is highlighted in the list.

Viewing the Information Page

Each item on the map and each item listed in the Find Menu results list has an information page

To view details about an item:

1. Highlight the desired point on the map or in the search results list and press **ENTER**.

An Information page appears with details about the item in a tabbed format. Depending on the type of item, additional options are available for viewing the item on the Map, viewing a tide chart, viewing the list of maps on your data card, and viewing the next item in the search results list.

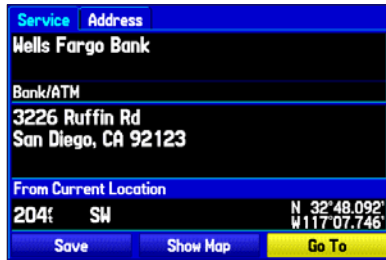

Information Page

2. Press **PAGE** or **QUIT** to exit the information page. You can also highlight one of the on-screen buttons and press **ENTER** to perform that operation.

Find Menu Options

To view additional options for the Find Menu, press the **NRST/FIND** key and then press **MENU**.

Enable Auto Arrange—automatically arranges the Find Menu. **Disable Auto Arrange** and **Restore Default** options appear when you select **Enable Auto Arrange**.

Near Other—allows you to select a new location from which to compile the Find items lists. Using the **Rocker** key, move the map arrow to the desired location and press **ENTER**.

Data Card Information—shows information about the detailed map data stored on the data card and allows you to select which maps are displayed on the Map page.

Additional selections are included in the options menu when you are navigating:

Near Next—compiles the Find items lists based upon the next turn in the route.

Near Destination—compiles the Find items lists based upon the route destination.

Near Current Route—compiles the Find items lists based upon the active route.

Creating Routes

The GPSMAP 296 lets you create and store up to 50 reversible routes, with up to 300 waypoints each.

Routes can be created in two ways. The first way is to select waypoints from the Find Menu, allowing you to see a list of the route points as you create the route. The second way is by selecting waypoints or map items from the Map page, allowing you to see each route point graphically on-screen as you create the route.



Route Tab Displaying the Route List



NOTE: If you have created a route (Flight Plan) with a Jeppesen point that is no longer current after you perform an update to your Jeppesen Database, the route is locked. You need to create a new route with current Jeppesen Database points.

To create a route using the Find Menu:

1. Press **MENU** twice to display the Main Menu page.
2. Use the **Rocker** key to highlight **Route** from the vertical list of tabs.
3. Press **MENU** to display the Route options menu. Select **New Route** and press **ENTER**. Or, highlight the first available blank route slot and press **ENTER**.
4. The Route Review page automatically opens, displaying a blank route. Press **ENTER** to find items to add to the route.
5. The Find page or Find Menu opens (depending on which Usage Mode you are in). Using the methods discussed in the “[Finding an Item](#)” section beginning on page 52, select a point to add to your route. When you find an item, highlight **OK** and press **ENTER** to add the point to the route. Repeat until you have added all of the points to the route.

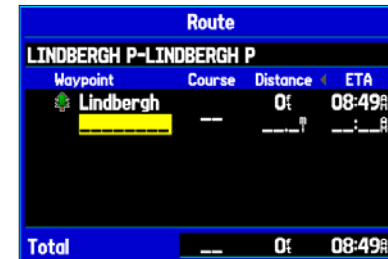

Creating a new route on Route Review page

To create a route graphically:

1. Press **MENU** twice to display the Main Menu page. Use the **Rocker** key to highlight **Route** from the vertical list of tabs.
2. Press **MENU** to display the Route options menu. Select **New Route** and press **ENTER**.
3. Highlight the first blank slot in the Route List page and press **MENU**. Use the **Rocker** key to highlight **Edit on Map** and press **ENTER**.
4. Use the **Rocker** key to highlight the location and press **ENTER**.

If you have selected an area of the map that is not a feature or waypoint, a new waypoint is created for that location. Press **ENTER** on the New Waypoint page to save the location as a waypoint and continue adding points to your route. You can edit the properties of this waypoint as you can with any waypoint.



Creating a new route on the map

5. Repeat until you have added all points to the route.
6. When finished press **QUIT** twice to return to the Route Review page. Or, press **MENU**, highlight **Edit as Text** and press **ENTER** to view the Route Review page.

To follow a saved route in Automotive Mode:

1. Press **MENU** twice to display the Main Menu page. Use the **Rocker** key to highlight **Route** from the vertical list of tabs.
2. Highlight the route you want to activate and press **MENU**.
3. Highlight **Activate Route** and press **ENTER**.
4. The Active Route page opens. Press **MENU**. Highlight **Follow Roads** and press **ENTER**. The GPSMAP 296 automatically generates a turn-by-turn route following roads.

If you want to follow roads on your route, be sure that you press **MENU** and select **Follow Roads** on the Active Route page.

Creating Waypoints

Waypoints are locations or landmarks you record and store in your GPSMAP 296. They may be checkpoints on a route or significant ground features. You can add waypoints to routes and even create a Go To directly to the selected waypoint.

Save your current location as a waypoint by pressing and holding **ENTER/MARK**. You can also find waypoints using the map or Find Menu and then store them in the unit before ever leaving home.

The GPSMAP 296 stores up to 3000 alphanumeric waypoints with a user-defined icon, comment, altitude, depth, and temperature available for each waypoint. Waypoints can be created using three basic methods:

- **ENTER/MARK** key—allows you to quickly mark your present position.
- **Graphically**—allows you to define a new waypoint position from the map display using the **Rocker** key.
- **Text Entry**—allows you to enter a new waypoint's position coordinates manually.

Marking Your Present Position

The **ENTER/MARK** key lets you quickly capture your present position to create a new waypoint. You must have a valid position (2D or 3D) fix to mark your present position. You can determine the satellite fix by looking at the **GPS** tab on the Main Menu.

To mark your present position:

1. Press and hold the **ENTER/MARK** key until the New Waypoint page appears, then release it. A default four-digit name and symbol are assigned for the new waypoint.

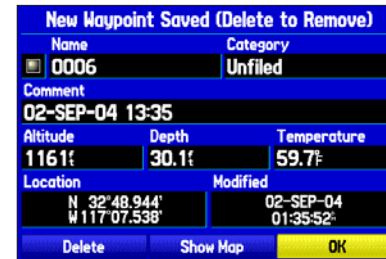

New Waypoint Page

2. To accept the waypoint with the default information, use the **Rocker** key to highlight **OK** and press **ENTER**.

To change any information on the New Waypoint page, highlight the appropriate field and press **ENTER**. After entering and confirming your changes, highlight **OK** and press **ENTER**.

Creating Waypoints From the Map

You can create a waypoint using the Map page. When you pan the map and move the arrow over a map item, you will see a highlighted description of that item. The GPSMAP 296 uses the map item text shown on the map as the default name and symbol for the new waypoint.

To create a new waypoint using the Map page:

1. Press **PAGE** until the Map page is displayed.
2. Use the **Rocker** key to move the arrow to the desired map position or map feature.
3. Press and quickly release **ENTER/MARK** to capture the arrow position. Pressing and holding **ENTER/MARK**, marks your present position, not the arrow's location.

If you have highlighted a map feature, an information page is displayed after you press **ENTER**. Use the **Rocker** key to highlight **Save** and press **ENTER** to save the item as a waypoint.

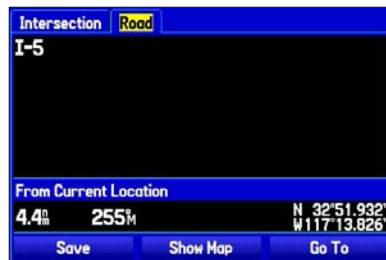

Map Feature Information Page

*Select **Save** to save the map feature as a waypoint*

4. The New Map Waypoint page appears. To accept the waypoint with the default information, highlight **OK** and press **ENTER**.

To change any information on the New Map Waypoint page, highlight the appropriate field and press **ENTER**. After entering your changes, highlight **OK** and press **ENTER**.

Creating a Waypoint by Entering Coordinates

You can manually enter position coordinates to create a waypoint. This method can be useful for creating a waypoint at a specific latitude/longitude position from a chart. You can manually change the location coordinates in the New Waypoint page to create a new waypoint or use the **Create Waypoint** selection in the User Points tab options menu.

To create a new waypoint by entering location coordinates:

1. Press **ENTER/MARK** to create a waypoint (or use your favorite method discussed in previous sections). The new waypoint is created with the next available waypoint number and the receiver's last known position as the default position.
2. On the New Waypoint page, use the **Rocker** key to highlight the **Location** field and press **ENTER**. Use the **Rocker** key to enter the desired position coordinates and press **ENTER** when finished.
3. To change any of the other information, highlight the appropriate field and press **ENTER**. Use the rocker key to enter the new information.
4. After entering your changes, highlight **OK** and press **ENTER**.

New Map Waypoint Saved (Delete to Remove)		
Name	Category	
0006	Unfiled	
Comment		
02-SEP-04 13:41		
Altitude	Depth	Temperature
991'		
Location		Modified
N 41°53.120'		02-SEP-04
W 087°37.268'		01:41:20
Delete	Show Map	OK

*To change the location of a waypoint, highlight the character you want to change in the **Location** field. Press Up or Down on the **Rocker** key to change the character. Repeat until the new location is entered.*

Following an Automotive Route

The GPSMAP 296 guides you to your destination using many tools, such as the Map page and Current Route page.

Track your Progress with the Map Page

You can track the progress of your route on the Map page. Your route is shown with a magenta line. The next turn is displayed in the top bar on the Map page.

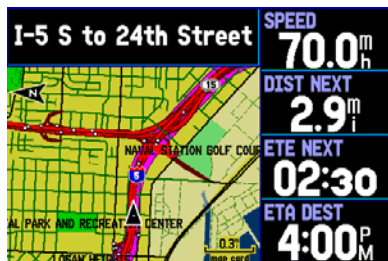

Map Page Displaying Your Route

Watch your Trip Data

Use the Trip Computer page to view your trip data. You can track your speed here, as well as other information related to your trip.

Current Route Page in Automotive Mode

Whenever you have activated a turn-by-turn route in the GPSMAP 296 set in Automotive Mode, the Current Route page shows each turn of the active route, with the distance to the turn, the street name, and estimated time to arrival and time of arrival. As you navigate a route, the next turn is displayed at the top of the list.

↑	2.1 ^m	Keep right onto I-5 S/ National Avenue	02:31 3:56 ^R
↑	2.1 ^m	Keep left onto I-5 S	02:36 3:56 ^R
↑	5.9 ^m	Turn right on ramp to 24th Street	05:59 3:59 ^R
↙	6.1 ^m	Turn left on Bay Marina Dr	06:17 3:59 ^R
↑	6.3 ^m	Arrive at Restaurant Yakata on right	07:21 4:00 ^R

Current Route Page

Starting and Stopping Navigation

Press the **Direct To** key to open the Navigate menu. Highlight **Stop/Resume Navigation**.

Editing Your Route

Once you are navigating a route, you can edit that route. You can add areas and roads to avoid as well as temporary detours to your current route. You can also add stops along your trip, called via points.

While navigating, press the **Direct To**  key to open the Navigate Menu, shown below.

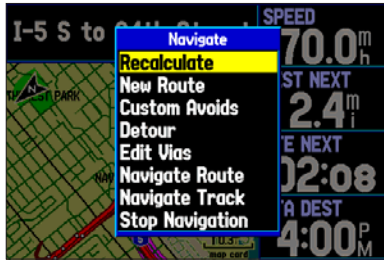

Navigate Options in Automotive Mode

While navigating a course

Entering Custom Avoids

Custom Avoids allows you to enter specific areas and roads that you would like to avoid in your navigation. **Custom Avoids** apply to all routes, but **Detours** apply to only the active route. Custom Avoids can be added while you are navigating a route or before you navigate.

To enter a custom avoid:

1. Press the **Direct To** key while in Automotive Mode. Or, open the Map page and press **MENU**.
2. Select **Custom Avoid**. Press **ENTER**.
3. Press **ENTER** when the **Add Avoid** button is highlighted.
4. Select **Avoid Road** or **Avoid Area** and press **ENTER**.
5. Use the **Rocker** key to move the arrow to the first point in the avoidance area. Press **ENTER** to select the first point.
6. Move the arrow to the end point and press **ENTER**. During route calculation and navigation, the GPSMAP 296 will avoid the area within the box or the selected area of the road.
7. When finished, highlight the **OK** button and press **ENTER**.

Creating a Detour

If, while navigating a route, there is road construction or a closed road, you can have your GPSMAP 296 create a detour route. While navigating a course, press the **Direct To**  key. Select **Detour** from the Navigate menu. Select the desired distance and press **ENTER**. The GPSMAP 296 will recalculate your course based upon your detour distance. To end the detour manually, press **Direct To** again and select **Cancel Detour**.

Adding and Editing Stops (Via Points)

You can add via points—points through which you would like to travel—to your route using the **Edit Vias** option. Via points are great for adding a stop at the gas station or bank to your route and are really helpful when planning a long trip.

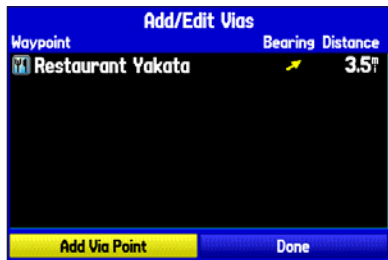

Add/Edit Vias Page

Showing the original route without via points

To add via points to your route:

1. While navigating your route, press the **Direct To**  key to open the Navigate menu.
2. Use the **Rocker** key to select **Edit Vias** and press **ENTER**.
3. The Add/Edit Vias window opens. Press enter with **Add Via Point** highlighted.
4. From the pop-up window, highlight either **Use Map** or **Find** and press **ENTER**.
5. If you selected **Use Map**, use the **Rocker** key to select the desired item on the map and press **ENTER**.
If you selected **Find**, select an item from the Find Menu as discussed in the “[Finding an Item](#)” beginning on page 52. Remember you can press **MENU** while the Find Menu is open to find an item near another location, such as your destination.
6. The new point is added to the route as displayed in the Add/Edit Vias page. Continue steps 2 through 4 until you have added all of the via points that you want. Highlight **Done** and press **ENTER** to apply the new via points to the route.

AUTOMOTIVE MODE PAGES AND FEATURES

This section discusses the major pages in Automotive Mode, such as the Map page, as well as some additional features, such as Routes and Points.

Map Page

Refer to page 29 through 34 in the “[Aviation Mode Pages and Features](#)” section for more details about the Map page.

The position marker (icon) that shows your travel on the Map page is a triangle symbol ▲ in Marine and Automotive modes. The GPSMAP 296 always powers up in position mode, with the last known location centered on the map. When you press the **Rocker** key, the GPSMAP 296 enters pan mode, which moves the map to keep the white arrow (map pointer) within the display area.

In Automotive Mode, by default, four user-selectable data fields appear on the right side of the screen that can be configured to display any one of the possible data options. The top of the screen displays the GPS status or the route leg. You can also add additional data fields to the page or select a full screen map without data fields.

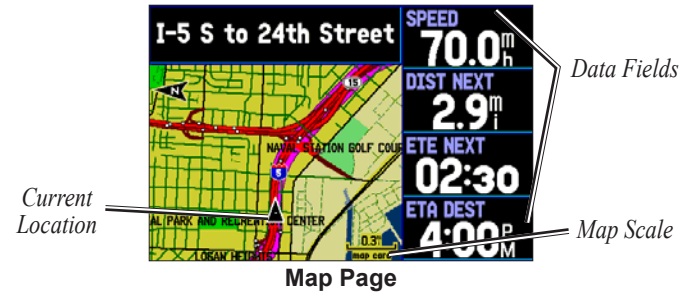

Press the zoom keys (**IN** and **OUT**) to change the map scale. Some items on the map are only displayed if the map is zoomed in to a certain level.

Press **MENU** to open the options menu for the Map page.

Enter **Custom Avoids** so your routes will not include areas you would like to avoid, such as high traffic areas.

Use the **Rocker** key to measure the distance between two objects on the map.

Change the page layout and data fields to customize the Map page.

Highway Page

The Highway page is only available in Marine Mode and Automotive Mode. In Automotive Mode, the Highway page is not displayed by default. See the directions to the right to display the Highway page.

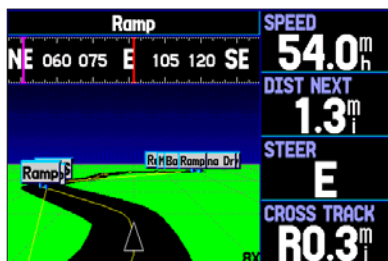

Highway Page

When you are navigating, the Highway page provides digital and graphic steering guidance to the destination. The right side of the Highway page features user-selectable data fields displaying useful navigation information. A compass ribbon is displayed at the top of the page to show your current heading as the violet bar and a red vertical bar indicates the bearing to your course.

To hide/show the Highway page:

1. Press **MENU** twice to display the Main Menu.
2. Use the **Rocker** key to highlight the **Display** tab.
3. Highlight the **Highway page** field and press **ENTER**.
4. Select **Off** to hide or **On** to show, and press **ENTER**.

Using the Highway Page

To stay on course, steer towards the violet bar (or arrows) until it lines up with the red bar in the middle. The bottom section of the screen provides visual guidance to the waypoint on a graphic highway display. The line down the center of the highway represents your desired track line.

As you head toward your destination, the highway perspective moves to indicate your progress to the waypoint and which direction you should steer to stay on course. If you are navigating a route, the Highway page shows each route waypoint in sequence connected by a black “road” with a white line down the middle, which is your desired track line. Nearby waypoints not in the active route can also be displayed. You can zoom in or out to display a larger or smaller view of the highway.

To change the highway perspective scale:

- Press **IN** to zoom in.
- Press **OUT** to zoom out.

Highway Page Options

The Highway page options menu allows you to define the data fields and select which waypoints and track are displayed on the screen. The data fields, located along the right side of the page, provide a user-selectable layout of various types of useful data. The layout may also be changed to display additional data fields.

To display and select the Highway page Options:

1. Press **PAGE** repeatedly until the Highway page is displayed.
2. Press **MENU**.
3. Use the **Rocker** key to highlight the desired option.
4. Press **ENTER**.

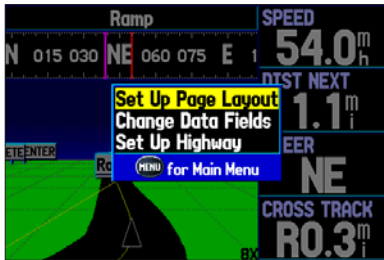

Highway Page Options Menu

The following options are available from the Highway page menu:

Setup page Layout—allows you to choose the number of data fields.

Change Data Fields—allows you to specify the type of data displayed in each data field used on the map display. This option is available from any of the main pages. See the “Appendix” for a listing of the data fields.

Set Up Highway—displays an options menu with two tabs: Line, and Waypoint. Each tab has On/Off settings for several options, such as enabling the line for the Active Leg and Track Log.

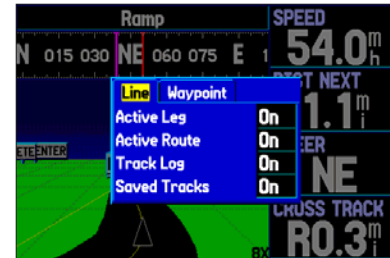

Set Up Highway

Current Route Page

Whenever you have activated a route in the GPSMAP 296 in Automotive Mode, the Current Route page shows each turn of the active route, with the distance to the turn, the street name, and estimated time to arrival and time of arrival. As you navigate a route, the turn list automatically updates to indicate the next turn at the top of the list.

↑	2.1 ^m	Keep right onto I-5 S/ National Avenue	02:31 3:56 ^R
↑	2.1 ^m	Keep left onto I-5 S	02:36 3:56 ^R
↑	5.9 ^m	Turn right on ramp to 24th Street	05:59 3:59 ^R
↙	6.1 ^m	Turn left on Bay Marina Dr	06:17 3:59 ^R
↑	6.3 ^m	Arrive at Restaurant Yakata on right	07:21 4:00 ^R

Current Route Page

You can scroll through the entire list by pressing the **Arrow** key Up or Down. Highlight any of the turns on the list and press **ENTER** to view the Next Turn page for that turn. The Current Route and Next Turn page display similar information, just in a different layout: The Next Turn page displays your next turn on a map.



Next Turn Page

Saving the Current Route

You can save the current route from the Current Route page. Press **MENU** to save the route. Press **ENTER** when **Save Route** is highlighted. Your route is automatically saved, using the starting point and destination as the route name. Highlight **OK** and press **ENTER** to complete saving the route.

Trip Computer

The Trip Computer page provides a quick reference for the important data you want to display while navigating a route in Automotive Mode. It indicates your current speed and many helpful statistics about your trip, such as bearing, average speed, and moving time.

Reset the Trip Computer before beginning a trip. If you make frequent stops, leave the GPSMAP 296 powered on to allow the unit to accurately measure elapsed time during the trip.

Trip Computer		
NE 3:55:39R	54.0^m_h	0.1^m_l 000000.1 ^l
Moving Average	Total Average	Maximum Speed
2.5^m_h	0.0^m_h	2.9^m_h
Moving Time	Stopped Time	Total Time
00:01:19	02:49:27	02:50:46

Trip Computer Page

Trip Computer Page Options

Press **MENU** while on the Trip Computer to display the options menu. The following options are available from the Trip Computer page. Some options are only available if you have changed the page Layout from the default (shown above).

Set Up Page Layout—allows you to choose the layout and number of data fields. You can also select a graphical **Dashboard**, select to show the Position Data page layout (**2 Columns**), or select **4 Big Fields** as the layout of the page. You can change the Data Fields on the **2 Columns** and **4 Big Fields** layout pages.

Change Nearest Type—allows you to specify the type of item to be used as the nearest item (displayed in the lower-left data field of the Position Data (**2 Columns**) layout). The choices differ based upon the Usage Mode you are currently using.

Reset Trip—clears trip information, except the maximum speed and the odometer.

Reset Max Speed—clears the maximum speed.

Reset Odometer—clears the running total of the distance traveled.

Reset All—clears all trip information including the maximum speed and odometer.

Editing and Managing Routes

The Route tab displays the routes you have created in your GPSMAP 296 unit. For complete information on routes, refer to the “Creating Routes” section beginning on page 55.

Viewing all of your Saved Routes

The Route tab in the Main Menu lists all of your saved flight plans and routes on one easy-to-read Route List.



Route Tab

Displaying the Route List

To view the route list:

1. Press **MENU** twice to open the Main Menu.
2. Highlight **Route** from the vertical menu of tabs using the **Rocker** key.

Using the Route Options

The Route tab in the Main Menu displays all the routes currently stored in memory, along with a descriptive name for each route. Highlight a route and press **MENU** open the options menu. From here you can activate the route, copy it, delete it, delete all routes, and create a new route. You can also set up the routes to manually transition to the next waypoint.

Manually Transitioning to the Next Waypoint

From the Route tab Option Menu, highlight **Set Up Routes** and press **ENTER** to set the route leg transition (or waypoint transition). Select **Distance** to enter a radius so that when you are within the entered distance, the GPSMAP 296 will lead you to the next point on your route.

When you select **Manual** you can transition to the next waypoint when you want while navigating a route. While you are navigating the route, open the Active Route page. Press **MENU**. Highlight **Next Route Waypoint** and press **ENTER** to have the GPSMAP 296 start routing you to the next point in your route.



NOTE: After you perform an update to your Jeppesen Database, verify that all of your flight plans (routes) in your unit are still current. If there is an obsolete Jeppesen aviation point in a saved route, the route will be locked and unusable. You need to create a new route with current Jeppesen Database points.

Navigating a Saved Route

The Navigate Route option allows you to easily select a saved route. For information about creating routes, refer to the “Creating Routes” section beginning on page 55.

To navigate a route in Automotive Mode:

1. In Automotive Mode, press the **Direct To** \blacktriangleright key.
2. Use the **Rocker** key to highlight **Navigate Route** and press **ENTER**.
3. Highlight the desired route and press **ENTER**.

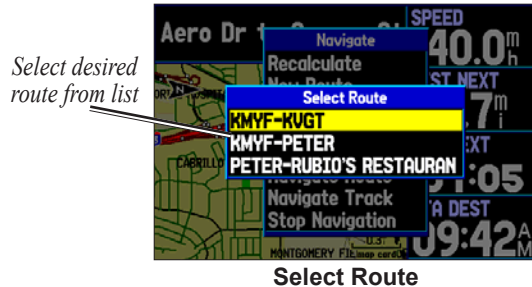

4. The Active Route page automatically opens with the route activated. Press **MENU** to open the options menu.
5. Highlight **Follow Roads** and press **ENTER** to create a turn-by-turn route (auto-route), which is displayed in the Current Route page.

Editing a Route

Once you have created a route, the Route Review page allows you to edit, change the name, and review route points of a selected route.

To change the name of the route:

1. Press **MENU** twice and highlight **Route**.
2. From the Route List page, use the **Rocker** key to highlight the name of the desired route and press **ENTER**.
3. With the Route Review page displayed, use the **Rocker** key to highlight the route name field at the top of the page and press **ENTER**.

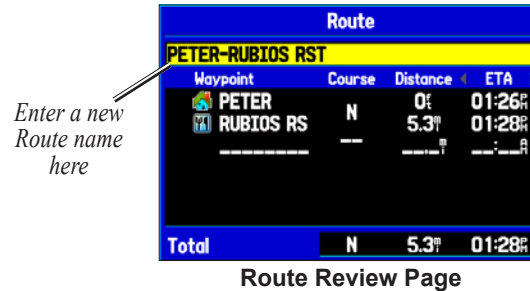

4. Use the **Rocker** key to enter the desired route name. Then press **ENTER**.

To review individual route points:

1. Press **MENU** twice and highlight **Route**.
2. Use the **Rocker** key to highlight the name of the desired route and press **ENTER**.
3. From the Route Review page, highlight the desired point and press **ENTER**.

Route			
PETER-RUBIOS RST			
Waypoint	Course	Distance	ETA
PETER	SW	0.1	01:26
Life's Littl	N	0.3	01:26
RUBIOS RS	---	5.8	01:28
Total	N	5.8	01:28

Route Review Page

4. On the point review page, choose **Next** (highlight the next point on the route list), **Show Map** (show the point on a map window), or **Save** (save the point as a waypoint) and press **ENTER**. If the route point is a user waypoint, you may edit any of the waypoint properties on the Waypoint page (see the “[Editing and Managing Waypoints](#)” section on page 72).

Once you are back on the Route Review page, the next point in the route is automatically highlighted. This allows you to review each point on the route by pressing **ENTER** repeatedly.

To add points to the route:

1. Press **MENU** twice to open the Main Menu. Use the **Rocker** key to select **Route**.
2. Use the **Rocker** key to select the desired route and press **ENTER**.
3. Use the **Rocker** key to highlight the spot in the route that you want to add the new point. (The new point is added before the highlighted route point.) Press **MENU**.
4. Highlight **Insert Waypoint** and press **ENTER**. The Find Menu automatically opens for you to search for and select the point you want to add to the route.
5. In the point review page, highlight **OK** and press **ENTER** to add the new point to the route.

To edit the route on the map:

1. Press **MENU** twice to open the Main Menu. Use the **Rocker** key to select **Route** from the vertical menu of tabs.
2. Select the desired route and press **ENTER**. Press **MENU** to open the Route Review page options menu.
3. Highlight **Edit on Map** and press **ENTER**.
4. Use the **Rocker** key to select a location on the route (the route turns white when the arrow is over the route). Press **ENTER**.
5. Use the **Rocker** key to drag the route to the new point location and press **ENTER**.

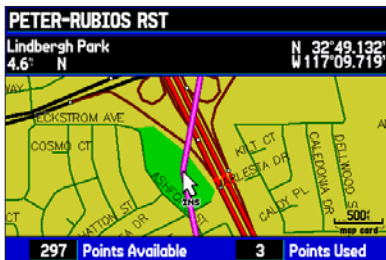

Editing the route on the map

6. If the New Waypoint page opens, edit the waypoint as desired, highlight **OK**, and press **ENTER**.
7. Repeat steps 4 through 6 until all desired points are added to the route. Press **Quit** when finished.

To set speed and fuel/plan your route:

1. Open the Route Review page options menu.
2. Highlight **Plan Route** and press **ENTER**. (Highlight **Set Speed and Fuel** in Aviation Mode.)

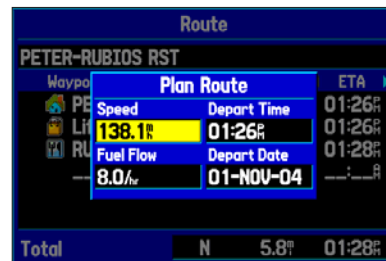

Entering Speed and Fuel Flow for trip planning

3. Enter the desired data for Speed and Fuel Flow. When in Marine and Automotive Modes, you also can enter the date and time of your departure. Press **QUIT** to return to the Route Review page.



NOTE: Fuel flow rates are measured in “units per hour.” System setting changes for units of measure (statute, nautical or metric) do not affect the fuel flow measure. You should enter fuel flow rates based upon information for your vehicle (such as the operator’s manual or performance specifications) and make note of the desired units of measure (gallons or liters).

Editing and Managing Waypoints

Once you have created and stored a waypoint, you can modify, review, rename, move, or delete it at any time through the Waypoint Review and Waypoint Edit Pages. These pages provide virtually the same information. For practical purposes, we will refer to these pages as the “Waypoint pages,” unless it is necessary to discuss them individually.

To access the Waypoint Review page from the Map:

1. Use the **Rocker** key to highlight the desired waypoint on the Map page.
2. Press **ENTER** to display the Waypoint Review page. If the waypoint is located on a map feature or MapSource or BlueChart feature, the Waypoint Review page may include additional tabs containing information about the other features at that location.



Waypoint Review Page Accessed from the Map Page

To access the Waypoint Edit page:

1. Press **MENU** twice to view the Main Menu.
2. Use the **Rocker** key to highlight **Points** from the vertical list of tabs, then highlight the desired waypoint from the list.



Points Tab in the Main Menu

3. Press **ENTER** to display the Waypoint Edit page. If the waypoint is located on a map feature or MapSource or BlueChart feature, the Waypoint Edit page will NOT display the details of the other map features.

Use either of these methods to access the Waypoint page so you can edit and manage the waypoint.

To change the waypoint name:

1. Open the Waypoint Review or Waypoint Edit page.
2. Highlight the waypoint name field and press **ENTER**.
3. Use the **Rocker** key to enter a new name and press **ENTER** when done.

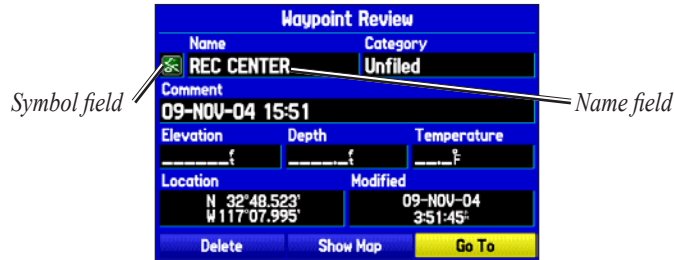
**Waypoint Review Page****To change the waypoint symbol or other element:**

1. Open the Waypoint Review or Waypoint Edit page.
2. Highlight the waypoint symbol field to the left of the waypoint name or highlight another field you want to change, and press **ENTER**.
3. Use the **Rocker** key to select the desired symbol or enter data and press **ENTER** when done.

To edit the next waypoint in the list:

1. After you have edited the waypoint on the Waypoint Edit page (shown above), highlight **Next** and press **ENTER**.
2. The Waypoint list is displayed with the next waypoint highlighted. Press **ENTER** to edit that waypoint.

Viewing the Waypoint on the Map**To view the waypoint on the map:**

1. From the Waypoint page, highlight **Show Map**.
2. Press **ENTER**. The waypoint is highlighted on a map with an information window at the top that shows the waypoint name, position and distance and bearing from your current position.

On the Show Map display, two additional options are available by pressing **MENU**:

Measure Distance—allows you to measure the distance and bearing between two points on the map (see page 33 for more information).

Point to on Main Map—returns to the highlighted waypoint on the Map page and exits the Waypoint page.

Adding a Waypoint to a Route

Append to Route adds the selected waypoint to the end of a route. This option is displayed when you are not navigating. When you are navigating to a destination, **Add to Current Route** is displayed. The selected waypoint is added to the current route before the route destination.

To add a waypoint to the end of the route:

1. Open the Waypoint page and press **MENU** to open the options menu.



Waypoint Options Menu

2. Select **Append To Route** from the options menu. The Select Route window appears.
3. Highlight the desired route or select **New Route** and press **ENTER**.
4. With **OK** highlighted, press **ENTER** to save the waypoint.

Averaging the Waypoint's Location

Average Location makes the unit take several sample location measurements for the waypoint and recalculate for a more accurate position reading.

To calculate the average location:

1. Open the Waypoint page and press **MENU** to open the options menu.
2. Select **Average Location** from the menu and press **ENTER**.

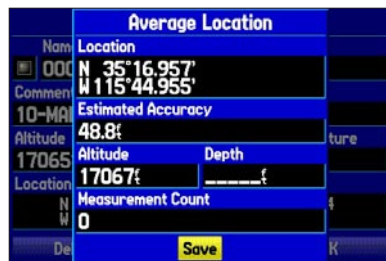

Average Location Page

3. The Average Location window appears. Watch the fields change as the unit calculates the average position of the waypoint. Press **ENTER** to save the position.



NOTE: You must have a GPS satellite fix before you can average a waypoint's location.

Projecting a Waypoint

You can also create a new waypoint by “projecting” the distance and bearing from a specific location to a new location.

To create a new waypoint by projecting its location:

1. Create a waypoint using your favorite method (discussed in previous sections). The new waypoint is created with the next available waypoint number and the receiver’s last known position as the default position.
2. Press **MENU** twice to open the Main Menu.
3. Highlight **Points** from the vertical list of tabs using the **Rocker** key.
4. Press **MENU** to open the New Waypoint page options menu.
5. Highlight **Project Location** and press **ENTER**.

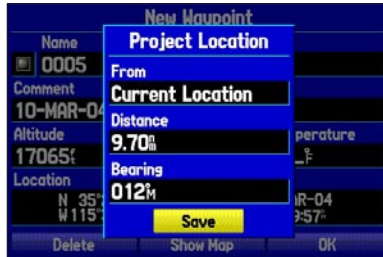

Project Location Menu

Enter the desired distance, bearing, and location to project from.

6. To change the location from which you are projecting the new waypoint, highlight the **From** field and press **ENTER**. The Find Menu opens.

Select the point from which you will project you new waypoint just as you would select a waypoint or point of interest. For more information see the “[Finding an Item](#)” section.

7. To adjust the distance that the new waypoint will be projected beyond the original waypoint, highlight the **Distance** field and press **ENTER**. Enter the projection distance and press **ENTER**.

To adjust the bearing that the new waypoint will be projected from the original waypoint, highlight the **Bearing** field and press **ENTER**. Enter the bearing and press **ENTER**.

8. When you have adjusted all elements of the projected location, highlight **Save** and press **ENTER**.
9. Make any other desired changes to the new waypoint data (such as the name or symbol), then highlight **OK** and press **ENTER**.

Organizing Waypoints into Categories

You can organize your waypoints into categories, which can help when managing and using your waypoints. For example, you can create a “Vacation” category that stores all of the waypoints you will use for your upcoming vacation. When the vacation is over, you can simply delete all the waypoints in that category by pushing a few buttons. You can create up to 15 categories.

To create a waypoint category:

1. From any of the waypoint pages or the Points Tab, press **MENU** to open the options menu.
2. Select **Edit Categories** and press **ENTER**.

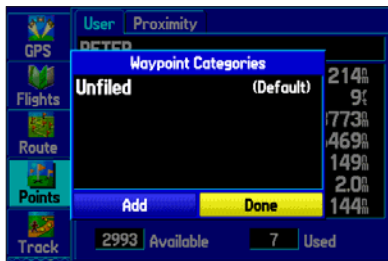

To add a Waypoint Category, select **Add** and press **ENTER**.

3. Use the **Rocker** key to highlight **Add** and press **ENTER**.



Enter the name of the category, select **Save**, and press **ENTER**.

4. Use the **Rocker** key to enter a name for the category.
5. Highlight **Save** and press **ENTER**.

Now, when you create or edit a waypoint, you can select the category from the **Category** list on the Waypoint page.

To delete a category:

1. With the Waypoint Categories window open, highlight the category to delete. Press **MENU**.
2. Select **Delete Category** and press **ENTER**.

To assign a category to a waypoint:

1. Open the Waypoint page. (You can also change the category on the New Waypoint page.)
2. Select the **Category** field and press **ENTER**.

**Waypoint Page**

3. Select the category you want to assign the waypoint to and press **ENTER**.

Managing Points

The Points tab of the Main Menu features two tabs, User and Proximity, that let you edit waypoints and manage a large number of waypoints quickly and efficiently. For more information about creating, editing, and deleting waypoints, refer to the “[Creating Waypoints](#)” section beginning on page 57.

To access the Points tab of the Main Menu:

1. Press **MENU** twice to open the Main Menu.
2. Highlight **Points** from the vertical list of tabs.

User Points Tab

The User Points tab displays a master list of all waypoints currently stored in memory. From the User list, you may review, edit, rename, or delete individual waypoints or delete all user waypoints.

**User Points Tab**

The total number of stored and available waypoints is displayed at the bottom of the User Points tab, with the stored waypoints arranged in numerical/alphabetical order.

To activate a Go To from the User Points tab:

1. Press **MENU** twice to open the Main Menu.
2. Highlight **Points** from the vertical list of tabs, then highlight **User** from the top row of tabs.
3. Use the **Rocker** key to highlight the desired waypoint.
4. Press **Direct To** \rightarrow . Highlight **Go To <Point Name>** and press **ENTER**.

Or, press **ENTER** when the waypoint is highlighted to review the waypoint on the Waypoint page. See the previous pages for detailed information on reviewing and editing waypoints.

Deleting Waypoints

You can delete waypoints from the waypoint list in the **Points** tab or from the Waypoint pages. To delete a waypoint from the Waypoint page, use the **Rocker** key to highlight the on-screen **Delete** button and press **ENTER**.



NOTE: Once you delete a waypoint, you cannot recover it from the unit. Back up important waypoints to a computer using the USB cable and software, such as MapSource, or write them down by hand.

To access the Points tab of the Main Menu:

1. Press **MENU** twice to open the Main Menu.
2. Highlight **Points** from the vertical list of tabs.
3. Press the **Rocker** key Right or Left to highlight **User** or **Proximity** to open that tab.



You can delete waypoints using a variety of methods. Press **MENU** to open the User Points options menu.

To delete a waypoint from the User Points tab:

1. From the User Points tab, use the **Rocker** key to highlight the waypoint you want to delete.
2. Press **MENU**, highlight **Delete Waypoint**, and press **ENTER**.
3. Press **ENTER** to confirm.

To delete waypoints by symbol or category:

1. From the User Points tab, highlight the waypoint you want to delete and press **MENU**.
2. Highlight **Delete by Symbol** or **Delete by Category** and press **ENTER**.
3. When deleting by symbol, highlight the symbol of the waypoint you want to delete and press **ENTER**.

When deleting by category, select the category you want to delete from the list and press **ENTER**.

4. Highlight **OK** and press **ENTER** to confirm. Choose **Cancel** or press **QUIT** to exit without deleting.

To delete waypoints by distance:

1. From the User Points tab, highlight the waypoint to be deleted and press **MENU**.
2. Highlight **Delete By Distance** and press **ENTER**.
3. Select **Less Than or More Than** and **ENTER** the desired distance using the **Rocker** key.
4. If desired, you can select a waypoint or point of interest as the **From** location. Highlight the **From** field and press **ENTER**. From the Find Menu, select the desired location and press **ENTER**. When **OK** is highlighted, press **ENTER**.
5. Highlight **Delete** and press **ENTER** to delete all waypoints within the set location. Choose **Cancel** or press **QUIT** to stop the deletion.

Proximity Points

The Proximity Points tab lets you define an alarm circle around a stored waypoint position. The alarm circle can help you avoid reefs, rocks, or restricted waters. Up to 100 waypoints may be listed with a maximum alarm radius of 99.99 nautical miles, statute miles, or kilometers.

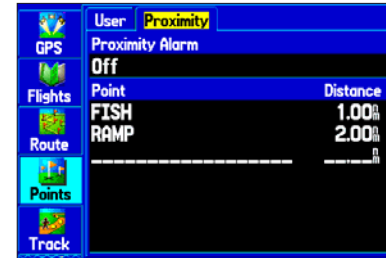

Proximity Points Tab

If a proximity alarm circle overlaps an existing alarm circle, a “Proximity Overlaps Another Proximity Waypoint” message appears. Because the unit only alerts for one of the overlap points, use caution when navigating in these areas. If you enter an alarm circle overlap, you are only alerted to the closest proximity waypoint.

To turn proximity alarms on or off:

1. Press **MENU** twice to open the Main Menu.
2. Highlight **Points** from the vertical list of tabs. Highlight **Proximity** from the row of tabs along the top of the screen.
3. Use the **Rocker** key to highlight the field below **Proximity Alarm** and press **ENTER**.
4. Select the desired **ON** or **OFF** setting and press **ENTER**.

To add a proximity waypoint:

1. From the Proximity Points tab, use the **Rocker** key to highlight an empty line on the Proximity List and press **ENTER**. The Find Menu appears.
2. Select the desired waypoint or point of interest from the Find Menu. With **OK** highlighted, press **ENTER** to select that point. (For complete information about the Find Menu, see [“Finding an Item”](#) on page 52)
3. The distance field is now highlighted. Press **ENTER** to begin entry of the proximity radius.
4. Use the **Rocker** key to enter a distance value (up to 99.99 units) and press **ENTER**.

To clear one or all proximity waypoints from the list:

1. Open the Proximity Points tab.
2. Use the **Rocker** key to highlight the proximity waypoint to clear and press **MENU**.



Proximity Points Tab Options Menu

3. To clear a single alarm, highlight **Remove Point** and press **ENTER**. To clear all proximity waypoints, select **Remove All** and press **ENTER**.
4. Use the **Rocker** key to highlight **OK** and press **ENTER**.

Managing Your Tracks

The GPSMAP 296 draws an electronic breadcrumb trail or “track log” on the Map page as you travel. The track log contains points along its path, including time, and position for each point.

The track log starts recording as soon as the GPSMAP 296 gets a location fix. For the best results, clear the track log before you start traveling because when the track log is full, new track points overwrite the oldest track points.

The percentage of memory used by the current track log appears at the top of the Active tab. After the track log is cleared, it displays zero percent. When the display reaches 100%, the most recent track points start to overwrite the least recent track points (if **Wrap** is selected for **Record Mode**). To avoid losing track points, save the track log when it approaches the 99% mark.

You must first save the track log before you can use the **Navigate Track** feature. The **Save** feature allows you to store up to 15 track logs from certain times and dates.

To access the Track tab:

1. Press **Menu** twice to open the Main Menu.
2. Highlight **Track** from the vertical list of tabs.

Setting up and Saving your Tracks



Active Track Tab

Record Mode—Wrap records over the oldest tracks when the track log reaches 100%. **Fill** records a track log until the track log is full (100%). When **Off** is selected, the unit does not record tracks.

Interval—Distance records track points after a specified distance has been traveled. **Time** creates track points after a specified time has elapsed. **Resolution** records track points based upon the resolution. The higher the resolution entered, the more points the unit creates to make the track.

Value—records a track according to the **Interval** and **Value**. Enter a specific distance, time, or resolution.

Color—select a color for the track when it is displayed on the map.

To clear the track log:

1. Press **MENU** twice to display the Main Menu.
2. Highlight **Track**, then highlight the **Active** tab to the right.
3. Select the **Clear** button and press **ENTER**.

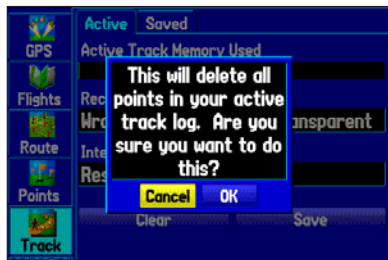

Clearing the track log

4. Highlight **OK** and press **ENTER**. Press **QUIT** to exit.

To save the entire track log:

1. Press **MENU** twice to open the Main Menu.
2. Highlight **Track**, then highlight the **Active** tab to the right.
3. Use the **Rocker** key to select **Save** and press **ENTER**.
4. A window pops up asking if you want to save the entire track log. To save the entire track, highlight **Yes** and press **ENTER**.

To save a portion of the track log:

1. Press **MENU** twice to open the Main Menu.
2. Highlight the **Track** tab, then highlight the **Active** tab.
3. Use the **Rocker** key to select **Save** and press **ENTER**.
4. To save only a portion of the track, highlight **No** and press **ENTER** when the pop-up window appears.
5. Select a beginning point and press **ENTER**. Select an ending point and press **ENTER**.



Saving a portion of the track log

6. The Track Review page automatically opens.
7. Highlight **OK** and press **ENTER** to save the track. Press **QUIT** to exit.

Saved Tab

The Saved tab lists all of the saved tracks in your unit.



Saved Tab

Press **MENU** to open the Saved tab options menu:

Review on Map—displays the highlighted track on the Map page.

TracBack—navigates the track. You can either navigate the track as it is saved, or you can navigate the track in reverse.

Delete Track—erases highlighted track from the unit's memory.

Delete All—erases all tracks from the unit's memory.

To edit a track:

1. Press Menu twice to open the Main Menu.
2. Highlight the Track tab. Press the Rocker key right to highlight the Saved tab.

3. Highlight the track you want to edit and press **ENTER**. The Track Review page opens. Make changes as desired.

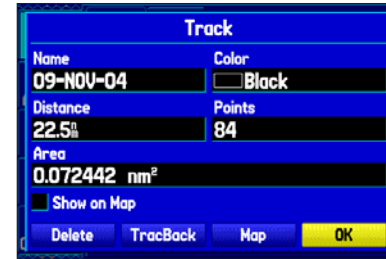

Track Review Page

4. Highlight the **Name** field and press **ENTER**. Use the Rocker key to change the name and press **ENTER**.
5. Select a different display color when the track is displayed on the map.
6. To display this track on the map, highlight the box next to **Show on Map** and press **ENTER**.
7. To begin a TracBack, highlight **TracBack** and press **ENTER**. For more information about the TracBack feature, refer to the next page.
8. To view the track on the map, highlight **Map** and press **ENTER**. Press **QUIT** to return to the Track tab.
9. Highlight **OK** and press **ENTER** to save the track. Press **QUIT** to exit.

Navigating a Saved Track

The TracBack function allows you to retrace your path using the track log automatically stored in the receiver's memory, which eliminates the need to store waypoints along the way. TracBack routes are created by reducing your track log into a route with up to 300 turns and activating an inverted route along those points. Once activated, a TracBack route leads you back to the oldest stored track log point, so it is a good idea to clear the existing track log before you start your current trip. You must save an active track log before you can navigate it as a TracBack.

To activate a TracBack using the Direct To key:

1. Press **Direct To** \rightarrow , then highlight **Navigate Track** and press **ENTER**.



Selecting a Saved Track

2. Highlight the track you want to navigate and press **ENTER**.

3. Use the **Rocker** key to select the point you want to navigate to (TracBack to) and press **ENTER**.

TracBack Tips

Once a TracBack has been activated, the GPSMAP 296 divides the track into segments called legs. Up to 300 temporary turns are created to mark the most significant features of the track in order to duplicate your exact path as closely as possible. To get the most out of the TracBack feature, remember these tips:

- Always clear the track log at the point that you want to go back to (such as a dock or campsite).
- The **Record Mode** option on the Active Track tab must be set to **Fill** or **Wrap**.
- If the track log **Interval** option on the **Active** tab is set to the **Time** option, the route may not navigate your exact path (keep the interval set to Resolution for best performance).
- If the receiver is turned off or satellite coverage is lost during your trip, the TracBack draws a straight line between any point where coverage was lost and where it resumed.
- If the changes in distance and direction of your track are too complex, 300 waypoints may not mark your path accurately. The receiver then uses the most significant points of your track so there will be fewer changes in direction.

BASIC OPERATION IN MARINE MODE

This section explains some of the more common Marine operations you will perform with your GPSMAP 296. Marine Mode is very similar to Automotive Mode and Aviation Mode. For explanations of topics not discussed here that pertain to Marine Mode, refer to that topic in the Aviation Mode or Automotive Mode sections.

To switch usage modes:

1. Press and hold the **PAGE** button.
2. Use the **Rocker** key to select either Aviation, Automotive, or Marine and press **ENTER**.

Marine Mode Page Sequence

Marine Mode features five main pages: the Map, Compass, Highway, Active Route, and Position Data pages. If you are connected to a sonar module, such as a Garmin GSD 20, an additional Sonar page is available.



Navigating in Marine Mode

Press the **Direct To**  key in on any page to begin navigating to a destination. The **Go To Point**, **Navigate Route**, and **Navigate Track** options operate the same as in Automotive Mode. Refer to the previous section for detailed instructions on those options. In Marine Mode, you can initiate Man OverBoard (MOB) navigation, which places a waypoint in the location and then navigates you back to that location.

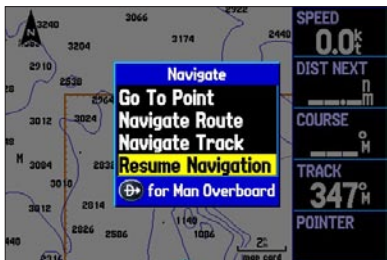

Navigate Options in Marine Mode



*Accessed by pressing the **Direct To** key*

Once you are actively navigating, you will see a magenta line that always runs from your current location to the destination on the Map page. You can use the Map page, Compass page, Highway page, and Position Data page to help navigate to your destination.

Man OverBoard (MOB)

The Man OverBoard function (MOB) lets you simultaneously mark and set a course to a position for quick response to emergency situations.

To activate the MOB function:

1. In Marine Mode, press and hold the **Direct To**  key or press the **Direct To**  key twice.

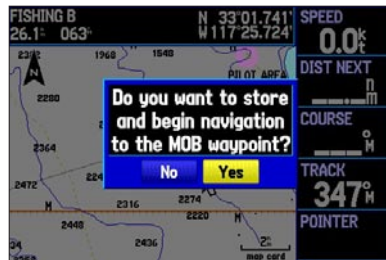

Man OverBoard confirmation screen

2. Press **ENTER** to confirm and begin navigating to the MOB position.



Once an MOB has been activated, an MOB waypoint with an international MOB symbol is created and the unit begins actively navigating to that point. Use any of the navigation Pages to guide you back to the MOB point. The MOB waypoint is stored in the waypoint list and may be deleted like any other waypoint.

MARINE MODE PAGES AND FEATURES

Marine Mode operates in a very similar fashion to Aviation Mode, while also providing many features and operations of Automotive Mode. Refer to the corresponding sections in the Aviation and Automotive sections for further details.

Map Page

Refer to page 29 through 34 in the “[Aviation Mode Pages and Features](#)” section for more details about the Map page.

The position marker (icon) that shows your travel on the Map page is a triangle symbol  in Marine and Automotive modes. The GPSMAP 296 always powers up in position mode, with the last known location centered on the map. When you press the **Rocker** key, the GPSMAP 296 enters pan mode, which moves the map to keep the white arrow  (map pointer) within the display area.

In Marine Mode, by default, four user-selectable data fields appear on the right side of the screen that can be configured to display any one of the possible data options. You can also add additional data fields to the page or select a full screen map without data fields.

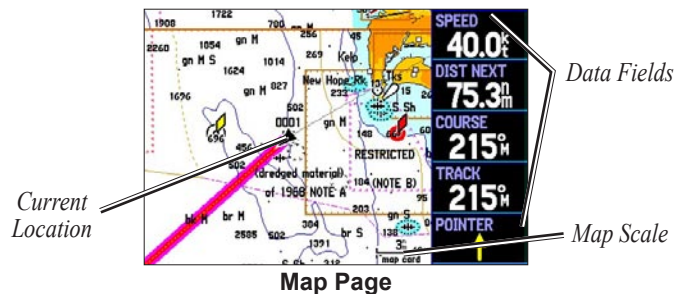

Press the zoom keys (**IN** and **OUT**) to change the map scale. Some items on the map are only displayed if the map is zoomed in to a certain level.

Press **ENTER** to quickly declutter (remove unwanted items) from the Map page.

Press **MENU** to open the options menu for the Map page.

Show and hide the heading line from the options menu.

Use the **Rocker** key to measure the distance between two objects on the map.

Change the page layout and data fields to customize the Map page.

Compass Page

During active navigation, the Compass page guides you to your destination with data fields and a graphic compass display with a bearing pointer.

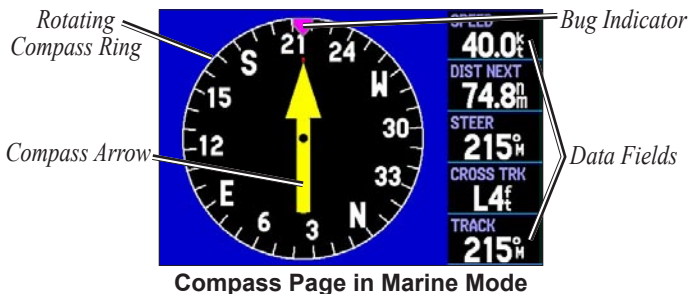

The middle of the page features a rotating “compass ring” that shows your course over ground (track) while you are moving. Your present course over ground is indicated at the top of the compass ring. The direction of the destination (bearing) relative to the course over ground is indicated by an arrow in the middle of the compass ring and a bearing “bug” on the outside of the compass ring.

The compass ring and bearing indicators work independently to show, at a glance, the direction of your movement and the direction to your destination. For instance, if the arrow points up, you are going directly to the waypoint. If the arrow points any direction

other than up, turn toward the arrow until it points up, then continue in that direction.



NOTE: You must be moving for the compass to accurately update and display your heading.

The right side of the Compass Pages features user-selectable data fields that display helpful information during active navigation. For definitions of data field settings, refer to page 145 of the “Appendix.”

Compass Page Options

The options menu on the Compass page allows you to customize the Compass page to your preferences. Like the Map page, the Compass page features user-selectable data fields on the right side of the display. When the Compass page is open, press **MENU** to open the options menu.

Show Course Pointer/Show Compass—toggles between showing the Course Pointer, which shows how far off you are from your desired course and how to get back on course, or showing the compass arrow. The Course Pointer is also referred to as a CDI or Course Deviation Indicator.

Show/Hide Bug Indicator—toggles between showing and hiding the bearing bug indicator (the purple tick mark on the compass ring).

Using the Marine Timer

The Marine Timer, specifically designed for sail boat racing, allows you to easily count up or down specified time increments. As common in sail boat racing, there is often a 5-minute warning countdown, followed by a 4-minute preparation countdown, and finally a one-minute final countdown. Then during the race, mariners may want to count up to keep track of their time. By default, all of these different countdowns and count ups can easily be performed with the GPSMAP 296 by pressing a few buttons.

You must change the Compass page layout to use the Marine Timer.

To open the Marine Timer:

1. Press **PAGE** repeatedly until the Compass page is displayed.
2. Press **MENU**.
3. Use the **Rocker** key to highlight **Set Up Page Layout** and press **ENTER**.
4. Highlight **2 Columns With Timer** and press **ENTER**. The Marine Timer is displayed in the lower right corner.

To use the Marine Timer:

1. Press the **Rocker** key Up or Down to select the time you want to count. Five (5) minutes is the default.
2. Press **ENTER** to start the timer. Use the **Rocker** key during the timing to quickly select a different length of time.
3. Press **ENTER** to stop timing.



Marine Timer on the Compass Page

As discussed previously, the timer is set to count down five minutes. If you want to change the length of time and the behavior of the timer, open the Timers Setup tab in the Main Menu.

To set the Marine Timer:

1. Press **MENU** twice to open the Main Menu.
2. Press the **Rocker** key Down to select **Setup** and then Right to select the Timers tab.
3. Highlight **Stop** next to **Marine** and press **ENTER** to change the timer's behavior. Highlight the desired behavior and press **ENTER**.
4. Highlight the time field, press **ENTER**, and then use the **Rocker** key to enter a new time. The maximum time is 59:59 (minutes: seconds). Press **ENTER** when finished.

DSC

The DSC page of the Main Menu (Marine Mode only) allows you to control and set up the Digital Selective Calling (DSC) features on the GPSMAP 296. Digital Selective Calling (DSC) uses marine VHF radio and Global Positioning System (GPS) technologies to transmit and receive location information. DSC is used by mariners for two major operations: Distress Calls and Position Reporting.

For more information about Digital Selective Calling and Maritime Mobile Service Identity (MMSI) numbers, refer to pages [141–142](#) in the “Appendix.”



DSC Page

Understanding Distress Calls

With your GPSMAP 296 properly connected to a VHF radio with DSC output, you may receive any DSC Distress Call within range. An alert message displays and a tone sounds when a Distress Call is received. The alarm only sounds on a Distress Call: Position Reports do not sound the alarm. Distress Calls are broadcast to all DSC users in radio range and appear with a blue and white checkered icon on the DSC Call List and Log tabs.

You also have the ability to input a caller’s name, if it is known. The caller’s name replaces the MMSI number as a reference once entered.

Understanding Position Reports

The Position Report operates similarly to the Distress Call. This type of contact is like a phone call: No emergency alarms are set off. Position Reports are not broadcast to all DSC users and appear with a gold boat icon.

Receiving DSC Calls

Each time you receive a Distress Call or Position Report, a review page opens—either a DSC Position Report page or a Distress Call page. Both pages contain identical fields to the DSC Entry Review page shown below.

Each entry in the Call List and Log has a corresponding DSC Entry Review page. This page operates similarly to the Distress Page and Position Report Page. From the DSC Entry Review, you can **Delete** the entry, **Save** it as a waypoint, or show the location on the map.

To review a call or log entry:

1. Open the Call List or Log from the **DSC** tab
2. Press Up or Down on the **Rocker** keypad to highlight the call you want to review.
3. Press **ENTER** to open the DSC Entry Review page.

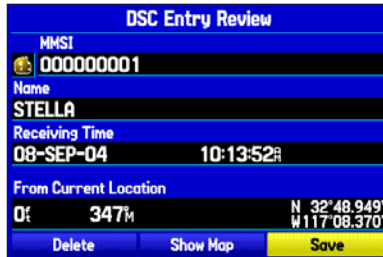

DSC Entry Review Page

DSC Call List

The DSC Call List displays the current calls received. The Call List displays the 50 most recent calls, even if the unit is left unattended. The Call List displays the most recent call from a vessel. If a second call is received, it replaces the first call in the Call List. Press **MENU** to sort the list and delete entries.



DSC Call List

DSC Log

When DSC calls are received, they are automatically stored in the Log, with the latest call at the top. The unit may store up to 100 logs. Once 100 logs are received, the oldest log file is removed when a new call is received. Press **MENU** to sort the list and delete entries.



DSC Log

Receiving a Position Report or Distress Call

After you have received a Position Report or a Distress Call, you can quickly navigate to the location. Highlight the desired call from the **Call List** or **Log** and press **Direct To**. The top selection in the Navigate menu is highlighted. Press **ENTER** to go to the location.

DSC Directory

The DSC Directory acts much like a phone book and can hold up to 50 entries. Pressing **MENU** from this page allows you to add a **New Item**, **Delete** a highlighted entry, or **Delete All** entries.



DSC Directory

To add a new Directory entry:

1. Open the DSC Directory in the Main Menu.
2. Use the **Rocker** key to highlight the first blank space in the directory list and press **ENTER**.
Or, press **MENU**, highlight **New Item**, and press **ENTER**.
3. Enter the MMSI number, the Name, and any comments.
4. When finished, highlight **OK** and press **ENTER**.

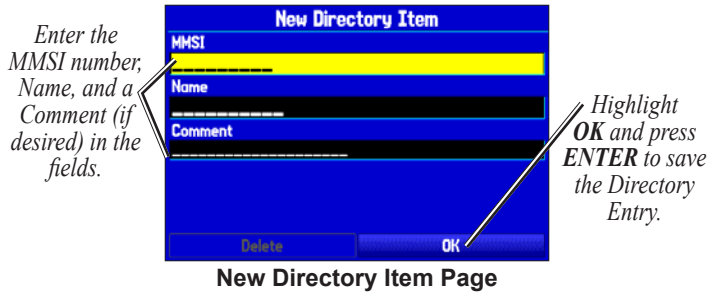

After creating a New Directory Item, the name created is attached to that particular MMSI number. If you return to the Log, the new name is displayed under the corresponding MMSI number.

Another way to input a name is from the Entry Review page or the DSC Distress Call or DSC Position Report pages. The Name and MMSI are sent to other Garmin GPS units: Only the MMSI numbers are sent to other non-Garmin DSC users.

Making a Distress Call

For a Distress Call, press the MayDay button on your VHF radio. The call transmits on an emergency channel with the MMSI number attached to the call, if you have DSC support. Any DSC-equipped mariner (on sea or land) within range can receive the call.

Setting up DSC

The DSC Setup tab allows you to turn DSC **On** and **Off**. If you have more than one chartplotter and only want DSC to display on another chartplotter, turn DSC off on this unit.

This Setup tab also allows you to simulate Distress Calls and Position Reports while the unit is in Simulator mode (see page 11). Simulating calls is helpful for practice before connecting to the real system. The Distress Call simulator also helps to check if alarms are working properly.

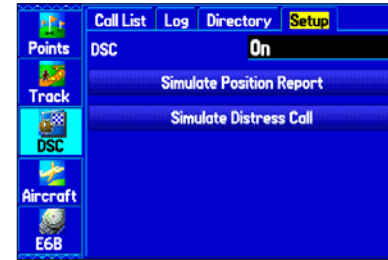

ADDITIONAL PAGES AND FEATURES

The Main Menu features some additional pages that will be useful to you as you plan trips and use your GPSMAP 296. Some of these pages have already been discussed in-depth in previous sections. This section only contains the additional pages and features found in the Main Menu that have not been discussed yet.

Setting Alarms

The Alarms tab of the Main Menu allows you to define alarm settings.

To access the Alarms tab of the Main Menu:

1. Press **MENU** twice to open the Main Menu.
2. Highlight **Alarms** from the vertical list of tabs.



Airspace Alarms Tab

To set an alarm:

1. Press **MENU** twice to open the Main Menu.
2. Use the **Rocker** key to open the Alarms tab.
3. Highlight the field below the alarm name you wish activate and press **ENTER**.
4. Change the mode to **On** (or the desired mode, where available) and press **ENTER**. If necessary, highlight the next field to the right and press **ENTER**, enter the desired settings, and press **ENTER** to finish.

When an alarm goes off, the alarm message appears on the display and the unit emits five (5) beeps. When you select an alarm to be persistent, the alarm message appears on the display and the unit beeps until you press **ENTER** to acknowledge the alarm. Press **NEAREST** to view the Airspace Information.

To set a persistent alarm:

1. Press **MENU** twice to open the Main Menu.
2. Use the **Rocker** key to open the **Alarms** tab.
3. Highlight the box next to the alarm you would like to make persistent (for example, **Restricted Areas**).
4. Press **ENTER** to place a check mark in the **Persist** box.

When an alarm goes off, it sounds until you acknowledge the alarm message by pressing **ENTER**.

Airspace Alarms

Class B, CTA; Class C, TMA; Towers, Cntrl Zones; Restricted Area; MOAs; Mode C Veils; Other SUAs—enables and disables the alarms. Select **On** to enable or **Off** to disable.

Altitude Buffer—sets the buffer for the altitude alarm. Highlight and press **ENTER** to enter a different value. Use the **Rocker** key to select the desired digits.

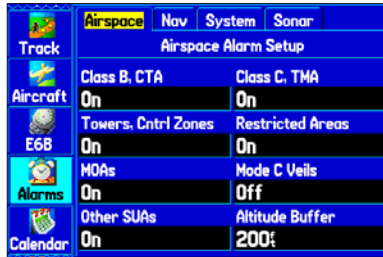

Airspace Alarms Tab

Navigation (Nav) Alarms

Next Turn—sets an alarm to indicate next turn in route. Select **Off** for no Next Turn alarm. Select **Dist** to enter a specific distance. For example, if you enter 1 nm, the Next Turn alarm will sound one nautical mile before you reach the next turn. Select **Time** to enter a specific time before the turn for the alarm to go off. For example, if you enter 00:02:00 the Next Turn alarm will sound two minutes before you reach the next turn. Select **Auto** for the unit to provide a Next Turn alarm at its discretion.

Arrival—sets an alarm to sound when you are a specified distance or time away from a destination waypoint. Select **Off** for no Arrival alarm. Select **Dist** to enter a specific distance. Select **Time** to enter a specific time before the destination for the alarm to go off. Select **Auto** for the unit to provide an Arrival alarm at its discretion.

Off Course—sets an alarm to sound when off your desired course. Select **On**, then enter a distance.

Anchor Drag—sets an alarm to sound when you have exceeded a specified drift distance. Select **On** and then enter a distance.

System Alarms

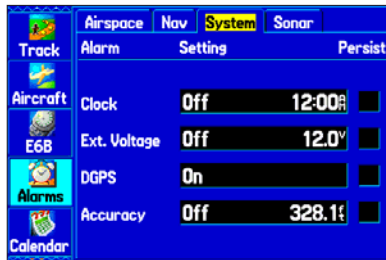

System Alarms Tab

Clock—sets an alarm based on the unit’s clock. Select **On** and then enter a specific time that you want the alarm to sound. The unit must be on for the clock alarm to work.

Ext. (External) Voltage—sets an alarm to sound when the external voltage drops below a specified amount. Select **On** and then enter a specific voltage.

DGPS—sets an alarm to sound when the unit loses a differential fix.

Accuracy—sets an alarm to sound when GPS accuracy falls outside of the user-set value. Select **On** and then enter a specific distance.

Sonar Alarms

You must be receiving sonar NMEA data for Sonar Alarms to work.



Sonar Alarms Tab

Shallow Water and **Deep Water**—sets an alarm to sound when you enter an area of water that is too shallow or deep.

Water Temp—sets an alarm to indicate if the water temperature has exceeded or dropped below a specific temperature, or fallen outside/inside a specific temperature range. Select **Above** or **Below** and then enter a specific temperature, or select **Inside** or **Outside** and enter a range of temperatures.

Drift—sets an alarm to sound when you have exceeded a specified drift distance. Select **On** and then enter a specific distance.

Fish—sets alarm to sound when unit detects a fish of the specified symbol size.

Using the Calendar

The Calendar allows you to plan flights or trips while also displaying sun & moon information and fishing & hunting information.

To add a route (or point) to the calendar:

1. Press **MENU** twice to open the Main Menu.
2. Highlight **Calendar** from the vertical list of tabs. The current day is displayed in Day View.

Highlight an arrow and press **ENTER** to change the date in the view.



Calendar Tab in Day View

3. Press the **MENU** key to display the options menu. Highlight **Add Route** (or **Add Point**) and press **ENTER**.
4. From the pop-up route list (or the Find Menu if Add Point was selected), select the route you want to add to the calendar and press **ENTER**.

Day View

The Day View displays sunrise and sunset times for your current date and location. A list of points and routes for the day are displayed in a list, as shown to the left. You can select a different date by highlighting an arrow and pressing **ENTER**. Press **MENU** to display an options menu.

Week View

The Week View provides many of the same elements as Day view, but the entire week is visible. Days with points or routes added to them are shown highlighted in green. Icons for the points and routes assigned to the date are shown along the bottom of the screen.

Month View

The Month View provides many of the same elements as Day view, but the entire month is visible. Days with points or routes added to them are shown highlighted in green. Icons for the points and routes assigned to the date are shown along the bottom of the screen.

Calendar Options

The options menu is available in all three calendar views. Press **MENU** on any of the calendar views to open the options menu. To jump to the Sun & Moon Information or Hunt & Fish tab, highlight **View Sun and Moon** or **View Hunt and Fish** and press **ENTER**.

Viewing Celestial Information

The Celestial tab of the Main Menu displays sun and moon information, data for the tide, and hunting and fishing information. You may display this data for your current position, a position from the map, or a waypoint location. Also, you may select a different date and time, or use the current data.

To access the Celestial Tabs of the Main Menu:

1. Press **MENU** twice to open the Main Menu.
2. Highlight **Celestial** from the vertical list of tabs.
3. Use the **Rocker** key to display the desired tab, such as **Sun & Moon**.

Sun & Moon Tab

The Sun & Moon tab provides you with sun rise/set and moon rise/set times. A graphic display of the moon phase is also displayed. You may view Sun & Moon information for any date or location. You can also use the play, fast forward, and stop buttons to view an animation of the Sun & Moon tab.

To view Sun & Moon information for a different date:

1. Use the **Rocker** key to highlight the **Date** field and press **ENTER**.
2. Use the **Rocker** key to change the digits of the date to the desired date. You can also use the **Zoom IN** and **OUT** keys to view information for another date. Press and hold **IN** or **OUT** to scroll quickly through dates.
3. Press **ENTER** when finished. The unit displays the sun and moon information for the date you entered or selected.

To use the current date again, highlight the Date field. Press **MENU**, highlight Use Current Date, and press **ENTER**.

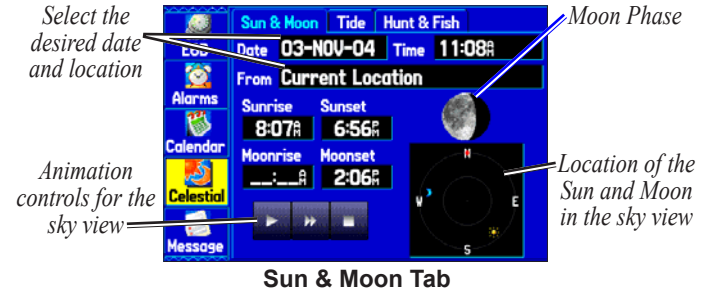

To view Sun & Moon information for a different location:

1. Use the **Rocker** key to highlight the **From** field and press **ENTER**.
2. Highlight **Use Find Menu** and press **ENTER**. The Find Menu automatically opens.
3. Select a waypoint or point of interest and press **ENTER**.
4. On the waypoint information page, press **ENTER**. The unit displays the sun and moon information for the location you selected.

To use the current location, highlight the **From** field. Press **ENTER**, highlight Current Location, and press **ENTER**.

Tide Tab

The Tide tab contains a graphical chart that displays tide station information in a 24-hour span starting at midnight station time. You can choose from different dates and over 3000 tide stations.

Enter the Date for which you want to view the tide information *Select the Tide Station for which you want to view the information*

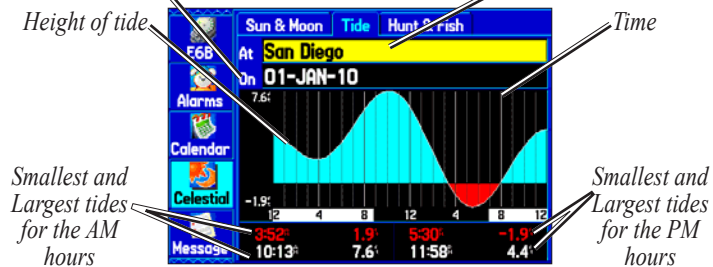

Tide Tab

The top of the page displays the tide station and date being referenced. The chart shows a 24-hour block of time, with the time progressing from left to right. The solid vertical lines represent 4-hour increments; the dotted vertical lines represent 1-hour increments.

The tide curve shows as a shaded area, with higher tides being taller and lower tides shorter. The bottom of the page indicates the times with the largest and smallest tides.

To view a tide chart for a different tide station:

1. From the Tide tab, highlight the **At** field and press **ENTER**. The Find Menu opens showing the Tide Stations.
2. Press **MENU** and select **Near Current Location, Near Current Route, Near Other** (select another location using the map), or **Near Destination** if desired. The list is then updated with your search requirements.
3. Select the desired station from the list and press **ENTER**.
4. The Tide Station Information page opens. Highlight **OK** and press **ENTER**.
5. The Tide tab displays again showing the tide chart for the selected tide station.

To view the tide chart for another date:

1. From the Tide tab with the desired chart displayed, highlight the **On** field and press **ENTER**.
2. **ENTER** the desired date with the **Rocker** key and press **ENTER**. You can also use the **Zoom IN** and **OUT** keys to view information for another date. Press and hold **IN** or **OUT** to scroll quickly through dates.
3. Press **ENTER** when finished. The unit displays the chart for the date you entered or selected.

To use the current date again, highlight the **Date** field. Press **MENU**, highlight **Use Current Date**, and press **ENTER**.

To view a chart's details for another time during the day (other than current time):

1. From the Tide tab with the desired chart displayed, press **MENU** and select **Move Cursor**.
2. Press the **Rocker** key Right or Left to view the chart at another time.
3. To return to the current time, press **MENU** and select **Stop Moving Cursor**.

To automatically start cursor mode to scroll the chart:

1. Use the **Rocker** key to highlight the **Date** field. Then press Down to activate the cursor (pan) mode.
2. Scroll the chart right to view the next day or left to view the previous day.

Hunt & Fish Tab

The Hunt & Fish tab provides you with predictions of the good and best times to hunt and fish in a selected location on a specific date.

To display the Hunt & Fish information:

1. Press **MENU** twice to open the Main Menu.
2. Highlight **Celestial** from the vertical list of tabs using the **Rocker** key.
3. Use the **Rocker** key to display the Hunt & Fish tab.



Hunt & Fish Tab

To view Hunt & Fish information for a different date:

1. Highlight the **Date** field and press **ENTER**.
2. Use the **Rocker** key to change the digits of the date to the desired date. You can also use the **Zoom IN** and **OUT** keys to view information for another date. Press and hold **IN** or **OUT** to scroll quickly through dates.
3. Press **ENTER** when finished. The unit displays the information for the date you entered.

To use the current date again, highlight the **Date** field. Press **MENU**, highlight **Use Current Date**, and press **ENTER**.

To view Hunt & Fish information for a different location:

1. Use the **Rocker** key to highlight the **From** field and press **ENTER**.
2. Highlight **Use Find Menu** and press **ENTER**. The Find Menu automatically opens.
3. Select a point and press **ENTER**.
4. On the information page, press **ENTER**. The unit displays the Hunt & Fish information for the selected location.

To use the current location, highlight the **From** field. Press **ENTER**, highlight **Current Location**, and press **ENTER**.

Viewing Messages

The Message tab of the Main Menu displays a list of messages generated by your GPSMAP 296. Use the **Rocker** key to scroll through the entire list of messages on the Log tab. Use the Log Filter tab to display only the types of messages you want to view.

To view the messages:

1. Press **MENU** twice to open the Main Menu.
2. Highlight **Message** from the vertical list of tabs.

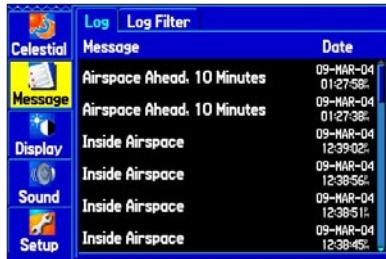

Message Log Tab

3. Use the **Rocker** key to highlight the desired message. Press **ENTER** to view detailed information about that message.

To show/hide messages using the Log Filter:

1. Press **MENU** twice to open the Main Menu.
2. Highlight **Message** from the vertical list of tabs.
3. Use the **Rocker** key to highlight the **Log Filter** tab. By default all messages are displayed.



Message Log Filter Tab

4. Use the **Rocker** key to highlight the message you want to hide and press **ENTER**.
5. The message name then appears in the **Hide** window. Highlight the message and press **ENTER** to show it again.

Viewing the Temperature



NOTE: You must be receiving proper sonar data from another device, such as a Garmin GSD 20 Sounder Module, to view temperature information.

The Temperature tab provides a visual graph of water temperature changes over a period of time. The graph reads from right to left, so that the most recent temperature measured is displayed on the far right side of the graph. The dotted lines within the graph indicate intervals in the temperature scale and the duration of time.



NOTE: Select **Temp** for the **Transducer** type in the **Sonar Setup**. See “[Setting up the Sonar](#)” on page 123 for more information.

Press **MENU** two times to open the Main Menu. Select **Setup** from the vertical row of tabs on the left, then select **Temperature** from the row of tabs along the top of the screen.

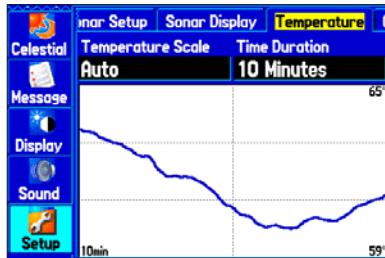

Temperature Tab

Changing the Temperature Display

The graph will adjust and displayed the temperatures changes according to the **Temperature Scale** and **Time Duration** settings.

Temperature Scale—select the desired degree span from the list. Select **Auto** to have the unit automatically determine the best range, or select a span of 2, 4, 6, 8 or 10 degrees.

Time Duration—set how fast or slow the temperature log scrolls: a shorter the time duration means a faster temperature log scroll. Select a duration from 1 minute to 2.5 hours.

Reset the Temperature Graph

To reset the scale range for the temperature graph, press **MENU**, highlight **Reset Auto Scale**, and press **ENTER**. This is useful when the scale spans a large range due to extreme temperature changes. You can only reset the scale when you select **Auto** for the **Temperature Scale**.

To restore the temperature graph to defaults, press **MENU**, highlight **Restore Default**, and press **ENTER**.

CUSTOMIZING YOUR GPSMAP 296

The Main Menu provides access to various waypoint, system, navigation and interface management, and setup menus.

Setting up the System

To customize how your GPSMAP 296 sounds and looks, adjust certain system settings in the Main Menu.

Adding a Welcome Message

The Welcome tab allows you to enter information, such as your name and address, that the unit can display when it is turned on. This feature can be helpful if your unit is ever misplaced.

To open the Welcome tab, press **MENU** twice to open the Main Menu. Select **Setup** from the vertical tab list. Then select **Welcome** from the row of tabs along the top of the page.

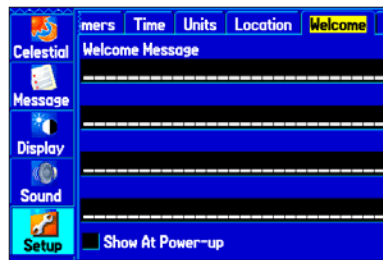

Welcome Tab of the Setup Tab

Enter the desired information in the fields. You do not need to enter information in every field.

To display this information at power up, highlight the box next to **Show at Power-up**. Press **ENTER** to place a check mark in the box. To hide the welcome information at power-up, remove the check mark from the box.

Changing the Page Layout and Data Fields

To customize the pages to display what you want, adjust the page layout and data fields.

You can adjust how the following pages look on the screen: Map, Terrain, Panel, Compass, Highway, Position Data, Trip Computer, and optional Sonar page. You can adjust the data fields on all of those pages as well.

To set up the page layout:

1. Press **PAGE** to display the page you want to change.
2. Press **MENU** to open the options menu.
3. Highlight **Set Up Page Layout** and press **ENTER**.

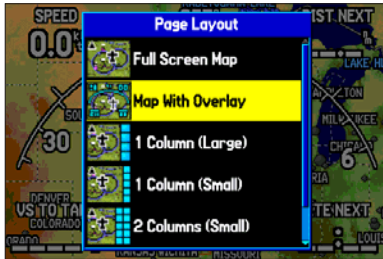

Changing the layout of the Map page

4. Select the desired option and press **ENTER**. The options vary between the three usage modes and the page you are setting up.

To change a data field display:

1. Press **PAGE** to display the page you want to change.
2. Press **MENU** to open the options menu.
3. Highlight **Change Data Fields** and press **ENTER**
4. Move the field highlight to the data field you want to change and press **ENTER**.
5. Press Up or Down on the **Rocker** key to highlight the data you want to display and press **ENTER**.
6. To return the field to the default setting, press **MENU** and then **ENTER**.
7. Press **QUIT** to exit.

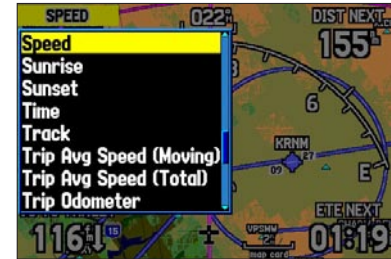

Changing a Data Field

Additional Map Data Displayed

You can view the data that is currently loaded on your GPSMAP 296 unit and data card.

To review/change data card information:

1. Access the Map page and press **MENU**.
2. From the options menu, highlight **Map Information** and press **ENTER**.

*Map Family highlighted. Press **ENTER** to view the individual maps in the family.*

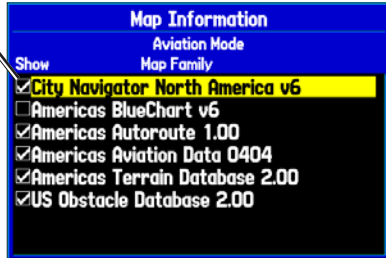

Data Card Information Page

3. The first page shows the Map Families that are stored on the data card and whether they are shown on the Map page.
To change the setting for a Map Family, highlight the box next to the Map Family name and press **ENTER** to select (check mark) or deselect (no check mark) the **Show** setting.
4. To view the list of maps within a Map Family, highlight the name of the Map Family and press **ENTER**.

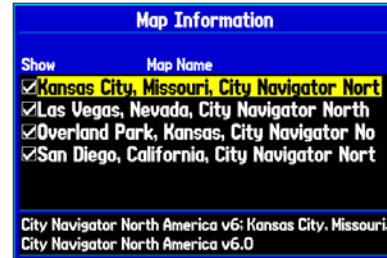

Individual Map Information Page

Showing the individual maps that are in the selected Map Family

5. To view detailed information about an individual map, highlight the Map Name and press **ENTER**. Highlight **OK** and press **ENTER** to exit the map information page.
6. To select/deselect individual maps for display on the Map page, highlight the box next to the desired map, and press **ENTER** to check/uncheck the **Show** box. Or, press **MENU** and select one of the options (**Show All**, **Hide All**, or **Show Defaults**), and press **ENTER**.
7. Press **QUIT** to exit the Data Card Information page.

Changing the Display

The Display tab of the Main Menu allows you to set several features of the display, such as what pages to display in the Main page sequence and how long the backlight stays on.

To view the Display tab:

1. Press **MENU** twice to open the Main Menu.
2. Highlight **Display** from the vertical list of tabs.

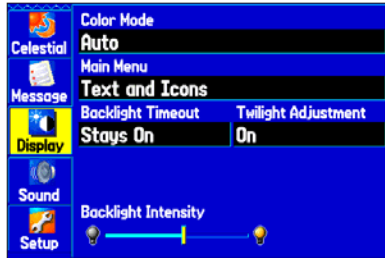

Display Tab

Color Mode—sets the display to a **Day**, **Night**, or **Auto** display. Auto switches from day to night at sunset and changes back at sunrise.

Main Menu—enables the main menu tabs to contain text and icons (default) or text tabs only.

Backlight Timeout—sets the backlight to stay on once it is turned on, or to time out after a selected period of time has elapsed when using the battery. The backlight stays on regardless of this setting when external power is used.

Twilight Adjustment—allows the unit to adjust the backlight for optimum viewing during twilight times.

Highway Page—enables the page and places it in the Main page sequence. Available in Marine and Automotive Modes only.

Compass Page—enables the page and places it in the Main page sequence. Available in Marine and Automotive Modes only.

Backlight Intensity—turns the backlight up or down. Press the **Rocker** key Right to increase the intensity or Left to decrease.

To restore the display to defaults:

1. Press **MENU** twice to open the Main Menu.
2. Highlight **Display** from the vertical list of tabs.
3. Press **MENU**.
4. Highlight **Restore Defaults** and press **ENTER**.

Changing the Sounds

The Sound tab of the Main Menu allows you to customize the sounds your GPSMAP 296 makes to suit your needs.

To view the Sound tab:

1. Press **MENU** twice to open the Main Menu.
2. Highlight **Sound** from the vertical list of tabs.

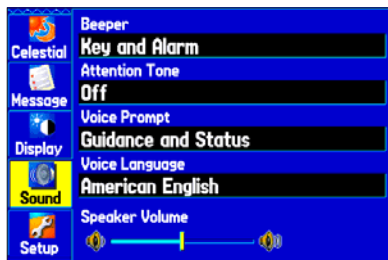

Sound Tab

Beeper—sets the beeper to chime during keypresses and alarms (**Key and Alarm**) or on **Alarms Only**.



***NOTE:** The Terrain, Obstacle, and Descent Rate alerts do NOT provide audible alarms.*

Attention Tone—turns the attention tone that sounds before the vocal prompts on and off.

Voice Prompt—sets the vocal prompt to operate for **Guidance and Status**, **Route Guidance Only**, or **No Voice Prompts**.

Voice Language—sets the language for vocal prompts.

Speaker Volume—sets the external speaker volume (when used). Press the **Rocker** key Right to increase the volume or Left to decrease.

To restore the sound to defaults:

1. Press **MENU** twice to open the Main Menu.
2. Highlight **Sound** from the vertical list of tabs.
3. Press **MENU**.
4. Highlight **Restore Defaults** and press **ENTER**.

Changing the System Settings

To open the System tab, press **MENU** twice to open the Main Menu. Select **Setup** from the vertical tab list. Then select **System** from the row of tabs along the top of the page.

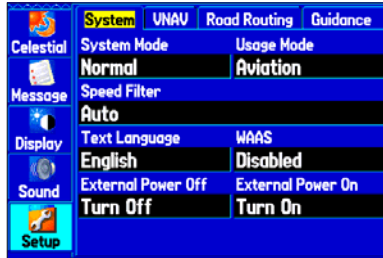

System Setup Tab

System Mode—sets the unit to operate in **Normal** mode, **Battery Saver** mode, or **Simulator** mode (for practice ONLY).

Usage Mode—sets the unit to the desired mode.

Speed Filter—allows the unit to average speed readings. Choose from **Off**, **Auto** (automatically controls filtering), or **On** (allows you to enter a value in seconds).

Text Language—allows you to select from various languages for the unit's on-screen display.

WAAS—**Disable** and **Enable** WAAS from this field.

External Power Off—allows you to select whether the GPSMAP 296 remains on (**Stay On**) or the unit turns off (**Turn Off**) when external power is removed from the unit.

External Power On—allows you to turn the GPSMAP 296 on (**Turn On**) or charge the battery (**Charge Battery**) when external power is applied to the unit.

Customizing the Units

The Units tab allows you to customize measurement units for the entire system. To open the Units tab, press **MENU** twice to open the Main Menu. Select **Setup** from the vertical tab list. Then select **Units** from the row of tabs along the top of the page.

Distance and Speed—select the unit to display your speed and distance traveled.

Direction Display—select the unit to display your direction. Mills is a unit of angle measurement used in military settings, in which 17.78 mills equal one degree.

Temperature—select the unit to display the temperature.

Altitude—select the unit to display your altitude.

Depth—select the unit to display the depth.

Vertical Speed—select the unit to display your vertical speed.

Pressure—select the unit to display the pressure.

Setting the Timers

To open the Timers tab, press **MENU** twice, select **Setup** from the vertical tab list, and **Timers** from the row of tabs along the top.

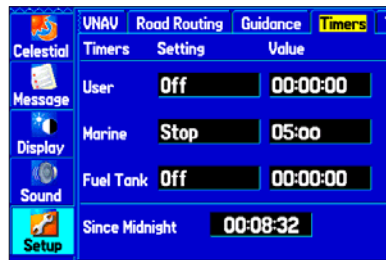

Timers Tab of the Setup Tab

User—allows you to set the timer to **Count Up** or **Count Down**. You can also **Reset** the timer and turn it **Off**. Enter a time to use when counting up or down to the right.

Marine—displayed on the Compass page. See page [89](#).

Fuel Tank—an estimation of the time left before you refuel.

Since Midnight—the time the unit has been turned on since midnight. This will reset if you restore **All Unit Defaults** from the **System** tab.

Changing the Time

The Time tab allows you to set the time format and zone. You can also set the unit to conform to Daylight Saving Time. The current time and date is displayed at the bottom of the page.

To open the Time tab, press **MENU** twice to open the Main Menu. Select **Setup** from the vertical tab list. Then select **Time** from the row of tabs along the top of the page.



Time Tab of the Setup Tab

Time Zone—allows you to choose a city in your correct time zone so the GPSMAP 296 will show the correct local time. Select **Other** to enter a UTC Offset.

If the incorrect date is displayed, press **MENU**, highlight **Set Date**, and press **ENTER**. You will then be prompted to enter the current year. The GPSMAP 296 will use this information when gathering satellite data to display the correct date.

Restoring Defaults

The following tabs in the Main Menu allow you to restore their defaults: Track, E6B, Alarms, Display, Sound, Setup.

To restore defaults:

1. Press **MENU** twice to open the Main Menu.
2. Use the **Rocker** key to highlight the desired tab.
3. Press **Menu** to open the options menu.
4. Highlight **Restore Default**.
5. Press **ENTER** to restore the tab to the defaults.

To restore all of unit's settings to the factory defaults at once, select **All Unit Defaults** from the options menu of the Setup tab.

Customizing the Routing and Guidance Settings

You can change the way the GPSMAP 296 generates routes in Automotive Mode. You can also change the way the GPSMAP 296 guides you during navigation.

Road Routing Settings

To open the Road Routing tab, press **MENU** twice to open the Main Menu. Select **Setup** from the vertical tab list. Then select **Road Routing** from the row of tabs along the top of the page.

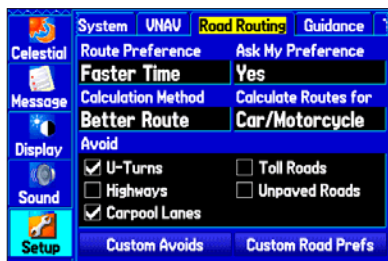

Road Routing Setup Tab

Route Preference—allows the unit to calculate a route for:

- **Faster Time**—routes calculated are faster to drive but may be longer in distance.
- **Shorter Distance**—routes calculated are shorter in distance but may take more time to drive.
- **Off Road**—creates a direct line from your current location to your destination. This is useful when you are travelling outside of detailed map coverage areas or where no roads exist.

Ask Me My Preference—determines whether you will be asked to select a Route Preference before route calculations.

Calculation Method—sets how the unit searches for the route.

- **Quickest Calculation**—calculates the route the quickest, but it might not produce the best route.
- **Quick Calculation**—takes a bit more time to calculate, but generates a better quality route.
- **Better Route**—generates an even better quality route, but uses a longer calculation time.
- **Best Route**—generates the most optimal route, but takes the longest time to calculate.

Calculate Routes for—sets route calculation for the particular vehicle you are operating to optimize the route for your vehicle type, as some roads have vehicle-based restrictions.

Avoid—allows you to avoid certain road types and maneuvers on your route. The unit uses these road types only if alternative routes take you too far out of your way or if no other road is available.

Custom Avoids—allows you to enter specific areas and roads that you would like to avoid in your navigation. Refer to page 61 for information on creating custom avoids.

Custom Road Prefs—allows you to avoid or use **Major**, **Medium**, and **Minor** roads using a slider scale. This is especially nice if you want to avoid major highways, for example. Select **Auto Set** to use preset values.

Guidance Settings

To open the Guidance tab, press **MENU** twice to open the Main Menu. Select **Setup** from the vertical tab list. Then select **Guidance** from the row of tabs along the top of the page.

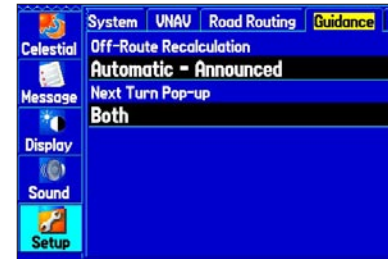

Guidance Tab of the Setup Tab

Off-Route Recalculation—allows you to set whether the unit prompts you when it is recalculating your route (**Prompted**), or whether the unit recalculates automatically. You can also set whether the unit announces the recalculation (**Automatic - Announced**) or recalculates silently (**Automatic - Silent**). You can also turn route recalculation **Off**.

Next Turn Pop-up—turns the Next Turn pop-up window **Off**, or opens the window when you hold the **Direct To** key (**Held Direct To Key Only**), opens automatically (**Automatically Only**), or **Both**.

Changing the Location Settings

To open the Location tab, press **MENU** twice to open the Main Menu. Select **Setup** from the vertical tab list. Then select **Location** from the row of tabs along the top of the page.

Refer to the “Appendix” of this guide for more information about location formats and map datums. Also visit the National Imagery and Mapping Agency at <http://www.nima.mil> for more information on grids and datums.

Changing the Location Format

When you change the **Location Format**, you change the coordinate system in which a given position reading is displayed. The default format is latitude and longitude in degrees, minutes, and thousandths of a minute (hddd°mm.mmm).

You should only change the position format if you are using a map or chart that specifies a different position format or want to use a format you are familiar with.

Selecting a Different Map Datum

Datums are used to describe geographic positions for surveying, mapping, and navigation and are not actual maps built in the unit. You should only change the datum if you are using a map or chart that specifies a different datum.

The default setting is WGS 84. The unit automatically chooses the best datum depending upon your chosen position format.



WARNING: *Selecting the wrong map datum can result in substantial position errors. When in doubt, use the default WGS 84 datum for best overall performance.*

Selecting a Different Heading Reference

You can select from **Auto Mag Var**, **True**, **Grid**, and **User Mag Var**. **Auto Mag Var** provides magnetic north heading references that are automatically determined from your current position. **True** provides headings based upon a true north reference. **Grid** provides headings based on a grid north reference (and is used in conjunction with the grid position formats).

User Mag Var allows you to specify the magnetic variation at your current position and provides magnetic north heading references based upon the variation you enter. Enter the magnetic variation of your current position in the **Magnetic Variation** field if you have selected **User Mag Var** for the heading.



WARNING: *If User Mag Var is selected, the unit does not automatically calculate and update the magnetic variation at your present position. You must update the magnetic variation as your position changes. Failure to update this setting may result in substantial differences between the information displayed on your unit and external references, such as a magnetic compass.*

Changing the Data Format

The COM 1 and COM 2 tabs allow you to control the input/output format used when connecting your unit to external devices. To open the COM 1 or COM 2 tab, press **MENU** twice to open the Main Menu. Select **Setup** from the vertical tab list. Then select **COM 1** or **COM 2** from the row of tabs along the top of the page.

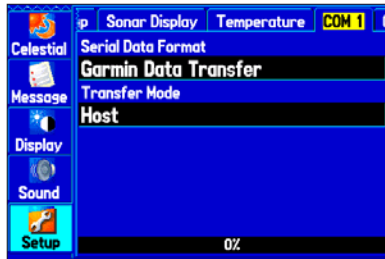

COM 1 Tab of the Setup Tab

Serial Data Format—sets the data format to one of the following:

- **Garmin Data Transfer**—the proprietary format used to exchange data with a PC or another Garmin GPSMAP 296. Garmin Data Transfer is disabled when the USB is connected and the unit automatically switches to USB format. When the USB is disconnected, the USB field changes to Transfer Mode.

- **Aviation In**—the proprietary format used for connection to a Garmin panel-mounted GPS receiver. Allows the GPSMAP 296 to display a Go To or route selected on the panel-mounted GPS receiver. This eliminates the need to enter the destination on both units.
- **GARMIN DGPS**—used to connect the GPSMAP 296 with a Garmin DGPS beacon receiver.
- **NMEA In/NMEA Out**—supports the input/output of standard NMEA 0183 version 3.01 data and sonar NMEA input support for the DPT, MTW, and VHW sentences.
- **Text Out**—allows the unit to output simple text data that includes, data, time, position, and velocity. The Baud can be set to 1200, 2400, 4800, or 9600.
- **RTCM In**—allows Differential GPS (DGPS) input using a standard RTCM format.
- **RTCM In/NMEA Out**—allows Differential GPS (DGPS) input using a standard RTCM format and also provides NMEA 0183 version 3.01 output.
- **RTCM In/Text Out**—allows Differential GPS (DGPS) input using a standard RTCM format and also outputs simple text data that includes, data, time, position, and velocity.
- **None**—provides no interfacing capabilities.

If you select GARMIN DGPS or RTCM In/NMEA Out format, you can control a differential beacon receiver directly from your GPSMAP 296 using the COM tab. You may have the unit automatically scan for the DGPS beacon signal, or you can enter the beacon frequency and bit rate on the unit, and the information will be used to tune the beacon receiver. If you use a DGPS receiver, WAAS capability is automatically turned off.

To have the unit automatically scan for a frequency:

1. With the unit set to GARMIN DGPS or RTCM In/NMEA Out, use the **Rocker** key to highlight the Beacon field and press **ENTER**.
2. Highlight **Scan** and press **ENTER**. The numbers in the Frequency field change as the unit scans from 284 kHz to 325 kHz, 200 bit rate, then 100, at 6-second intervals.

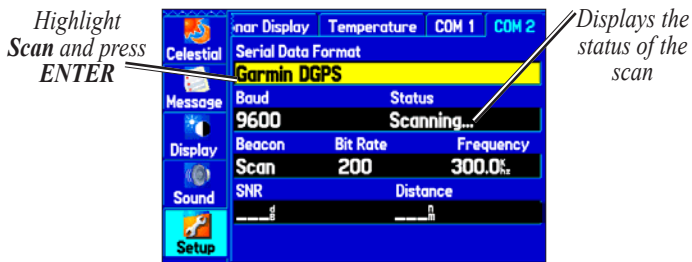

COM 2 tab of the Setup tab with GARMIN DGPS selected

The Status field displays one of the following:

- **Tuning**—the unit is attempting to tune to the specified frequency and bit rate.
- **Scanning**—the unit is automatically scanning through the frequencies and bit rates.
- **Receiving**—the unit is receiving DGPS signal and ready for operation.
- **Check Wiring**—the unit is not making connection with DGPS receiver.

To restart the scan:

1. Press **MENU**.
2. Highlight **Restart Scan** and press **ENTER**.

To manually enter a frequency and bit rate:

1. With the unit set to **GARMIN DGPS** or **RTCM In/NMEA Out**, use the **Rocker** key to highlight the **Beacon** field and press **ENTER**.
2. Highlight **User** and press **ENTER**.
3. Highlight the **Frequency** or **Bit Rate** field, press **ENTER**, and enter a frequency or bit rate. Press **ENTER** when done.

When the unit is receiving a DGPS signal, the SNR (Signal to Noise Ratio) and Distance fields show data. The SNR range is 0 dB to 30 dB, with 30 being the best. The Distance may or may not show data, depending upon the signal being broadcast from the DGPS site.

The DGPS beacon transmitters are operated by the United States Coast Guard (or similar government agency in other countries), which is responsible for their accuracy and maintenance. For DGPS transmitter problems or to find the most updated list of frequencies and coverage areas, contact your local USCG or see their Web site at <http://www.navcen.uscg.mil/>.

Advanced NMEA Output Setup

If you are going to interface the GPSMAP 296 with another piece of equipment (such as a radar or autopilot), the unit needs to be set to output NMEA data. The NMEA data transmission can be customized to keep the output rate at two seconds. If too many NMEA sentences are activated, the unit may take longer than two seconds to update.

To access the Advanced NMEA Output Setup:

1. Press **MENU** twice to open the Main Menu.
2. Use the **Rocker** key to select **Setup** from the vertical tab list.
3. Select **COM 1** or **COM 2** from the row of tabs along the top.
4. Highlight the field below **Serial Data Format**. Press **ENTER**.

5. Select **NMEA In/NMEA Out**. Press **ENTER**.
6. Press **MENU** to open the options menu. Select **Advanced NMEA Setup** and press **ENTER**.

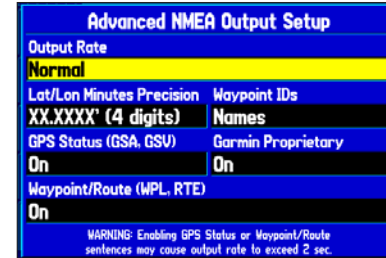

Advanced NMEA Output Setup

The Advanced NMEA Output Setup page allows you to set the output rate, change the precision of the Lat/Lon minutes, set Waypoint IDs to names or numbers, as well as turn on and off the GPS status, the GARMIN Proprietary sentences, and Waypoint/Route (WPL, RTE).

GPSMAP 296 NMEA Sentence Output (NMEA version 3.01 compliant):

- Always transmitted: GPRMC, GPGGA, GPGLL, GPBWC, GPVTG, GPXTE, GPRMB
- Switchable sentences: GPGSA, GPGSV, GPWPL, GPRTE
- GARMIN proprietary: PGRME, PGRMZ, PGRMM

SETTING UP AND USING SONAR

This section covers the additional sonar options for the GPSMAP 296 when used in conjunction with a GSD 20 Sounder Module. Read the *GSD 20 Installation Instructions* to properly install the sounder module. When you power up your GPSMAP 296, the GSD 20 automatically powers on.



NOTE: You **MUST** have a GSD 20 installed and connected to your GPSMAP 296 to use the sonar features.

The Sonar page is added to the end of the page sequence when you are in Marine Mode. To view the Sonar page, press **PAGE** or **QUIT** repeatedly until it is displayed.

Showing Sonar on the Map Page

You can change the layout of the Map page to display a split screen to show the sonar and Map page. You must be in Marine Mode to use the sonar feature.

To display the Sonar page on the Map page:

1. Press and hold **PAGE**. Highlight **Marine** and press **ENTER**.
2. Press **PAGE** or **QUIT** to display the Map page.
3. Press **MENU**. Use the **Rocker** key to highlight **Set Up Page Layout** and press **ENTER**.
4. Highlight **Map with Sonar** and press **ENTER**.

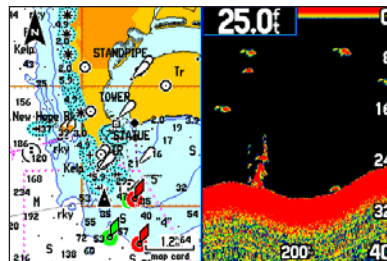

Map Page with Split Screen

To resize the Map page sonar split screen:

1. After displaying the Sonar and Map page together in the split screen, as described in the previous steps, press **MENU**.
2. Highlight **Size Split** and press **ENTER**.
3. Use the **Rocker** key to move the vertical double-arrow Right or Left until the screen is divided how you want it.
4. Press **ENTER** to complete the size split.
5. To stop resizing the screen, simply press **QUIT**. You can also press **MENU**, highlight **Stop Resizing**, and press **ENTER** to stop resizing the screen and retain the previous split setting.

Using the Sonar Page

When combined with a GSD 20 Sounder Module, your GPSMAP 296 becomes a powerful fishfinder/flasher with the Sonar page. If a GSD 20 is attached, but the unit does not detect a transducer, a “Sonar Turned Off” message appears across the Sonar page. If a GSD 20 is not attached, the Sonar page only appears when the unit is in Simulator Mode.

The middle of the page contains a right-to-left moving sonar image of the water beneath your boat. Items appear as they pass under your transducer. Those items on the right side of the screen are closer to you than those on the left. Along the right side of the screen is an adjustable scale that reflects the depth of the area being displayed. The top left corner displays the Adjustment Option, the depth, and the water temperature.

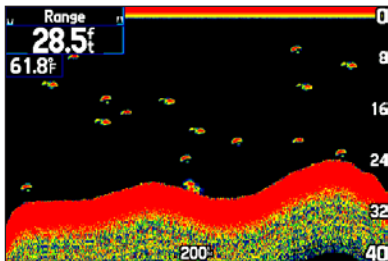

Sonar Page

The sonar returns show as red (strongest), then oranges (strong), yellows (medium), greens (weaker), and blues (weakest). The **Fish Symbols** option allows you to view the actual sonar data, a fish symbol or a combination of both. When the unit is set to **Dual**, the appearance of the fish symbols changes. Fish symbols from the center of the beam (200 kHz) are solid (or narrow arches), but the returns from the edges of the beam (50 kHz) are hollow (or wide arches).

The sonar display may also be set to show a split screen view of a zoomed portion of the sonar, bottom lock (display scaled from the bottom up), or a combination of these options. For example, you may choose to show dual frequency at a 2X zoom (Dual 2X) on one half and normal range dual frequency (Dual) on the other half. The current display mode is displayed at the bottom of each sonar display.

Read the “[Understanding Sonar](#)” section beginning on page 126 for more on information about sonar.

Adjusting the Sonar Page

The Adjustment Menu allows direct access to the settings and features most commonly used on the Sonar page. There are ten main adjustment options available: Range, Zoom, View, Gain, Target Level, Whiteline, Frequency, Depth Line, Noise Reject and Scroll. Use the **Rocker** and **ENTER** keys to make all adjustments. The currently selected option appears in the upper left corner.

To select an adjustment option:

Use one of the following methods to select an adjustment option:

- Press the **Rocker** key right or left to scroll through the adjustment options. When the desired adjustment option is displayed, press **ENTER**.
- Press **MENU**, highlight **Adjustments**, and press **ENTER**. Use the **Rocker** key to highlight the desired adjustment and press **ENTER**.

Once you have selected an adjustment option, press the **Rocker** key Up or Down to change the setting.

You may also press **MENU** and highlight the desired shortcut setting to quickly change to commonly used settings/values.

Press **ENTER** to accept the new setting (or press **QUIT** to cancel) and return to the Sonar page.

Adjustment Options

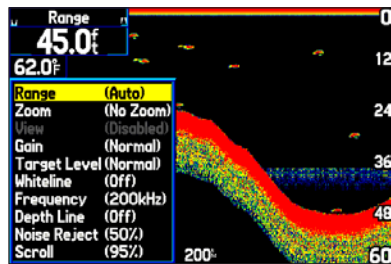

Sonar Adjustments

Scroll—adjusts the rate that the sonar display scrolls from right to left. If you are sitting still or the sonar display is moving too fast, slow the scroll rate or pause the scrolling.

Range—sets the display depth range used for viewing. The unit can be set to automatically track the bottom or set to a user-specified depth range.

Zoom—used to quickly select a display zoom scale or to split the display. When a scale other than **No Zoom** is selected, the Adjustment Menu displays a new selection labeled **View** or **Span**. The Zoom function is divided into six display levels:

- **2X Split**—shows two reduced-size sonar pictures at the same time. The right half of the display screen shows the complete sonar picture at its original scale. The left half shows a portion of the original picture at 1/2 depth scale.
- **2X Zoom**—displays the 2X zoomed picture on the full screen.
- **4X Split**—shows two reduced pictures, the right at the original depth scale and the left at 1/4 the original depth scale.
- **4X Zoom**—displays the 4X zoomed picture on the full screen.
- **Btm (Bottom) Split**—shows two reduced pictures, the right at the original depth scale and the left showing sonar returns from the bottom up. All target depths read as a distance from the bottom.
- **Btm (Bottom) Lock**—displays returns from the bottom up on the full screen.



***TIP:** Quickly zoom in and out of the Sonar display by pressing the **IN** and **OUT** keys. Deactivate the zoom function by pressing the **OUT** key until the **No Zoom** setting appears.*

View/Span—available when a **Zoom** scale other than **No Zoom** is selected. The **View** or **Span** setting is used to change the viewing range of a zoomed display. If the display is 2X or 4X split, only the zoomed portion on the left side of the display is affected by the change. If the display is Bottom Split or Bottom Lock, **Span** adjusts how far off the bottom the unit displays data.

Gain—allows you to control the sensitivity of the unit’s receiver, which provides flexibility in what is displayed. To see more detail, increase the receiver sensitivity by selecting a higher gain. If there is too much detail or if the screen is cluttered, select a lower gain.

Target Level—adjusts which colors are used to display sonar information. A **Color Bar** appears on the right side of the screen as you adjust this setting. A higher percentage results in more strong-signal colors displayed on the sonar display. A lower percentage results in more weaker-signal colors displayed on the sonar display. This setting does not increase or decrease the unit Gain.

Whiteline—controls how the unit displays information about the bottom type (hard or soft). With the Whiteline Off, the bottom return displays as red. Set Whiteline at **Normal** or **1–100%** to determine bottom hardness. See page 128 for more information.

Frequency—allows you to choose a transducer frequency. Frequency refers to the “pitch” of the sound that the transducer sends and receives.

Depth Line—adds a horizontal depth line across the display that is used to measure the depth of underwater objects. The depth of the line appears in a box on the right side of the line. Press Up or Down on the **Rocker** key to move the line on the sonar display.

Noise Reject—helps filter unwanted noise from the sonar display. The Noise Reject can be turned **Off**, set to **Normal** (automatically adjusts for optimum viewing) or to a fixed **1–100%** setting. When setting the Noise Reject, remember that a higher noise rejection setting is less likely to show fish or structures.

Resizing the Split Screen

You can adjust the way the split screen is displayed. This option is only available when a zoom scale other than **No Zoom** is selected.

To resize the Sonar page split screen:

1. From the Sonar page split screen, press **MENU**.
2. Using the **Rocker** key, highlight **Size Split**, and press **ENTER**.
3. Move the horizontal double-arrow Left or Right using the **Rocker** key until the desired vertical width line shows, then press **ENTER**.
4. If you wish to cancel this operation, press **QUIT** or press **MENU**, highlight **Stop Resizing**, and press **ENTER**.

Using the Pointer on the Sonar Page

You can display the pointer (arrow)  to reference sonar items and mark underwater waypoints. This makes it easier to find and use an object such as a stump for a future fishing location. When using this feature, the Sonar page pauses. The depth continues to update while the display is paused, but the unit does not show any new sonar data until the Sonar page resumes scrolling. You may see a discontinuity from where the sonar information stops and where it starts again.

To mark an underwater waypoint:

1. From the Sonar page, press **MENU**, highlight **Show Pointer** and press **ENTER**.
2. Use the **Rocker** key to move the cursor to the location you want to mark. Press **ENTER**. The New Map Waypoint page appears.
3. To change the name, symbol or depth, highlight the appropriate field and press **ENTER**. Make your changes and press **ENTER** when done.
4. When done, highlight **OK** and press **ENTER**.
5. To return to the standard Sonar page, press **QUIT**; or press **MENU**, highlight **Hide Pointer**, and press **ENTER**.

Setting up the Sonar

Use the Setup tab in the Main Menu to set up the Sonar page. Press **MENU** two times to open the Main Menu. Select **Setup** from the vertical row of tabs on the left, then select **Sonar Setup** from the row of tabs along the top of the screen.

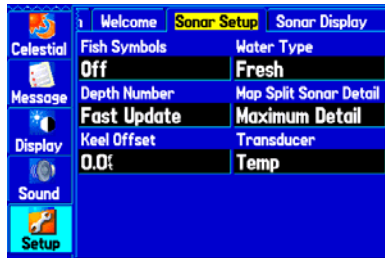

Sonar Setup Tab of the Main Menu

Fish Symbols—select how the Sonar page displays underwater targets and background information. If you select **Off**, the unit displays all of the available information about the underwater environment. If you select a fish symbol, the Sonar page displays only the information related to that symbol.

Water Type—select the proper water type you are boating in. Since sound waves travel through Fresh and Salt water at different rates, it is necessary to select the **Water Type** to ensure accurate readings on the unit.

Depth Number—select how efficient the digital depth update rate is. **Fast Sonar Update** updates quicker and is recommended for low-noise water deeper than 50 feet. **Auto** is best for shallow water or high-noise areas, has a slower screen update, and is best used if you travel a wide variety of depths.

If the unit is unable to track the bottom for any reason, the digits in the depth window flash on and off to alert you that the unit is not tracking the bottom.

Map Split Sonar Detail—select how much detail is displayed on the Map page with the sonar displayed. **Full Range** shows data using the **Range** setting of the Sonar page, regardless of **Zoom** or **Bottom Lock**. **Maximum Detail** shows any **Zoom** or **Bottom Lock** data from the Sonar page.

Keel Offset—enter the surface reading for the depth of a keel. This makes it possible to measure depth from the bottom of your keel instead of from the transducer's location. Enter a positive number to offset for a keel. It is also possible to enter a negative number to compensate for a large vessel that may draw several feet of water. The **Keel Offset** is reflected in the depth reading.

Transducer—select the type of transducer that you are using. If you are using a speed-capable transducer/sensor, select **Temp, Spd**.

Calibrating the Water Speed

If you select **Temp, Spd** is for the **Transducer** option on the Sonar Setup tab, you also need to calibrate the water speed to ensure that the **Water Speed** displayed on your unit is accurate. The calibration should take place in water having little or no current.

The unit automatically uses the GPS ground speed, if it is available, for comparison on the calibration. If a GPS ground speed is not available, use either your boat's speedometer reading (not always accurate) or a stopwatch to determine your speed over a certain distance. To find out your speed, divide the distance by the time.

To calibrate the water speed:

1. From the Sonar Setup tab, use the **Rocker** key to highlight **Calibrate Water Speed** and press **ENTER**.
2. Bring the boat to a cruising speed. Both the top ground and uncalibrated water speeds is shown at the bottom of the calibration window. Note your top speed, then stop the boat, and press **ENTER**.

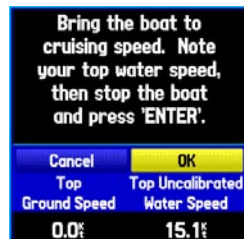

Calibrating the Water Speed

3. By default, the top ground speed is automatically shown. If a ground speed is not available, the top uncalibrated water speed is used instead. If the new speed is correct, highlight **OK** and press **ENTER**.

If you wish to manually enter a calibration, press **ENTER** while the speed is highlighted, enter a new speed, and press **ENTER**.

If the boat is not moving fast enough or the speed sensor is not outputting a speed, "Boat Is Not Moving Fast Enough To Calibrate" displays at the bottom of the screen. Check that the speed sensor wheel is moving or safely increase boat speed. If there is a problem with the speed sensor or if a speed sensor is not installed, "Water Speed Sensor Is Not Working" appears at the bottom of the display. Check connections of speed sensor cables.

Setting up the Sonar Display

You can setup how the sonar information is displayed on the screen. Press **MENU** two times to open the Main Menu. Select **Setup** from the vertical row of tabs on the left, then select **Sonar Display** from the row of tabs along the top of the screen.

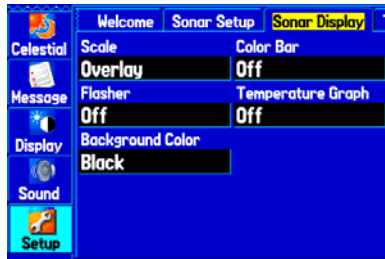

Sonar Display Setup Tab

Scale—select how and where you want the depth scale to be displayed.

Color Bar—select **On** to show a gradient scale of the current **Target Level** setting on the Sonar Setup tab.

Flasher—select **On** to display a graphic Flasher representation on the far right side of the sonar display. This graphic Flasher displays structure and bottom returns much the same as a true Flasher. You may find this feature particularly useful when using **Fish Symbols**.

Temperature Graph—select **On** to display a temperature graph along the bottom of the Sonar page.

Background Color—select the color for the Sonar page and the sonar on the Map split.

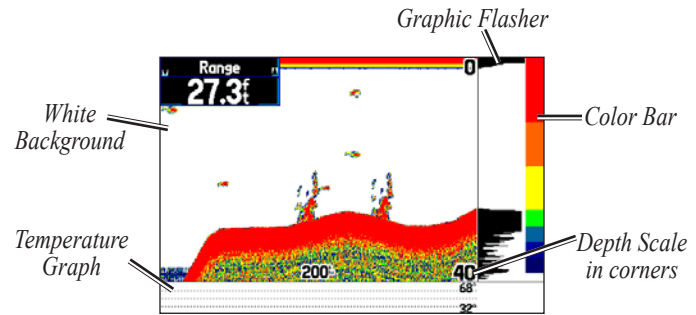

Sonar Page with the Sonar Display settings changed

Understanding Sonar

The transducer mounted on your vessel transmits sound waves toward the bottom of a lake, stream, or seabed in a cone-shaped pattern. When a transmitted sound wave strikes an underwater object—such as the bottom, a piece of structure, or a fish—sound is reflected back to the transducer. The transducer collects the reflected sound waves and sends the data to the GPSMAP 296 to be processed and displayed. The underwater data is shown on the Sonar display in the order that it is returned: first returned is the first on the display.

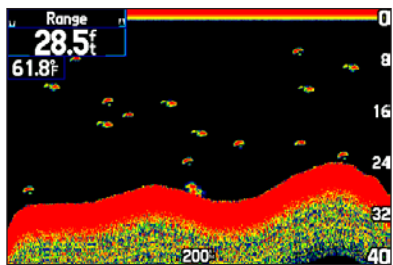

Sonar Page

Generally speaking, if the only thing between the transducer and the bottom is water, the first strong return comes from the bottom directly below the transducer and sets the bottom level. Weaker secondary returns provide the detailed data. Stronger returns display in darker colors, with red being the strongest return.

Understanding the Sonar Display

One of the first things to understand about sonar is that the transducer sends a beam down to the bottom of the water, much like the beam of a flashlight. The beam starts small near your vessel and expands as it gets to the bottom. Refer to “Transducer Coverage” for more detailed information.

The Sonar page does not display a three-dimensional representation of the underwater environment; the display is in two-dimensions, much like if you took a picture of an aquarium. Only the depth of the item in the water is displayed. The Sonar display does not show you where an item is located horizontally in the water, as shown in the drawings below. The fish is not directly above the tree in reality, but it may look like they are on the Sonar page.

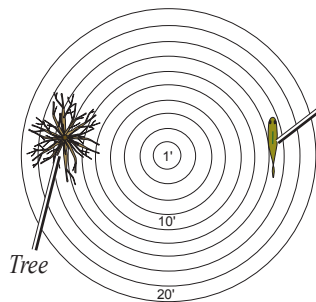

Aerial View of the Water

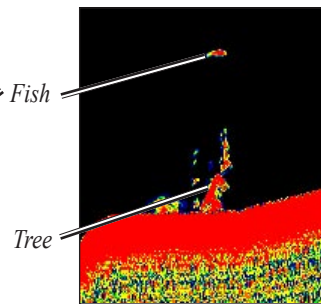

Sonar Display

Transducer Coverage

The area covered by the transmitted sound waves is determined by the cone angle of the transducer and the water depth. The wide cone angles (40°) associated with low frequencies (50 kHz) provide a large coverage area for finding fish within a coverage width that is approximately $2/3$ of the water depth. However, this also means that wide cone angles produce less bottom detail and resolution. As shown in the drawing on the near right, the 40° cone angle produces a coverage area of approximately a 20-foot diameter circle at a 30-foot depth.

The narrow cone angles (10°) associated with the high frequencies (200 kHz) provide better bottom resolution and crisper detail, but cannot show a large coverage area for finding fish. The 10° cone angle provides a coverage width that is approximately $2/10$ of the water depth. As shown in the drawing on the far right, the 10° cone angle produces a coverage area of approximately a 6-foot diameter circle at a 30-foot depth.

Dual frequency mode combines both frequencies to get the best coverage area and contour/depth readings.

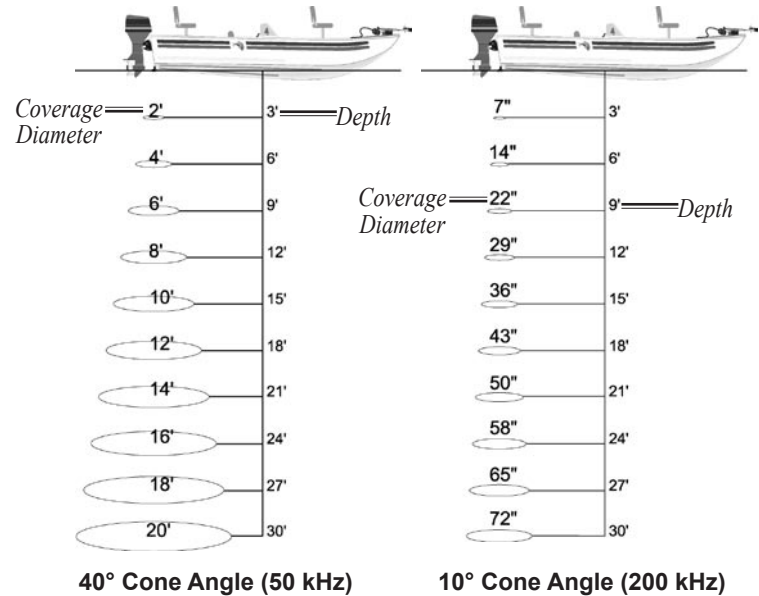

Whiteline

The GSD 20 Sounder Module can help you determine whether the bottom is hard or soft. When the sonar sound waves are reflected back by the bottom, a hard bottom returns a stronger signal than a soft bottom. A thin whiteline indicates a softer bottom, while a thick whiteline indicates a harder bottom. Normally, a red line is used to show the point where water meets the bottom. This line follows the bottom contour, along with any significant objects lying on the bottom. The unit uses the whiteline function to make the bottom layer information easier to distinguish.

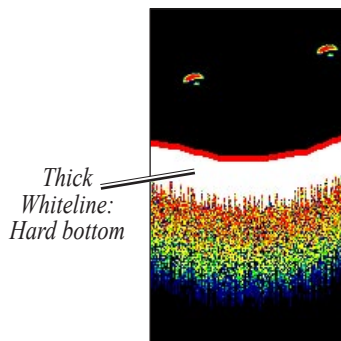

Whiteline On

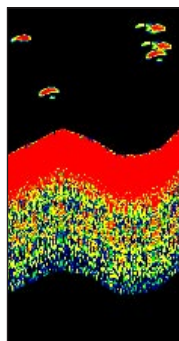

Whiteline Off

Thermoclines

A rough definition of a thermocline is a break in water where the water temperature changes faster than the water above it. Thermoclines are shown as the weakest colors.

One of the unique features offered by Garmin is See-Thru[®] technology, which allows the GPSMAP 296 to hear both weak and strong signals simultaneously so as to identify fish returns under the toughest conditions, such as suspended in thermoclines or even hiding near structures. See-Thru technology allows the GSD 20 Sounder Module to “see” through thermoclines and helps locate fish where they live—and fish love thermoclines!

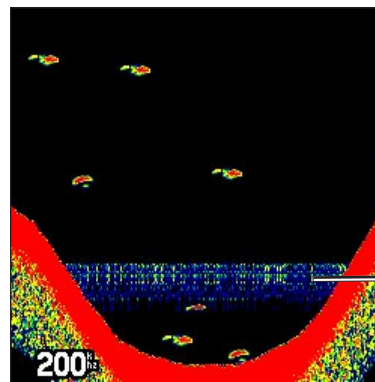

Thermocline

APPENDIX

Specifications

Physical Specifications

Size:	5.7" W x 3.2" H x 1.9" D (14.5 x 8.1 x 4.8 cm)
Weight:	13.6 oz (0.39 kg)
Display:	3.75" diagonal (9.5 cm) Transflective, 256-color display with backlighting (480 x 320 pixels)
Case:	Fully gasketed, high-impact plastic alloy, waterproof to IEC 60529 IPX7
Temp. Range:	5°F to 140°F (-15°C to 60°C)

Power

Battery:	Rechargeable lithium-ion
Battery Life:	5 to 15 hours depending upon the backlight setting
Source:	11–35 VDC
Fuse:	3AG-1.5 Amp

Performance

Receiver:	Differential-ready 12 parallel channel receiver
Acquisition Times:	Approx. 15 seconds (warm start) Approx. 45 seconds (cold start) Approx. 5 minutes (First Time/AutoLocate®)
Update Rate:	1/second, continuous

Accuracy

GPS:	15 meters (49 feet) RMS 95% typical
DGPS (USCG):	3–5 meters (10–16 ft), 95% typical
DGPS (WAAS):	< 3 meters (10 ft) 95% typical with DGPS corrections
Velocity:	0.1 knot RMS steady state
Dynamics:	6 g's

Care Information

To resolve problems that cannot be remedied using this guide, contact Garmin Product Support in the U.S.A. at 800/800.1020 or Garmin Europe at 44/0870.8501241.

Cleaning the Unit

The GPSMAP 296 is constructed of high quality materials and does not require user maintenance other than cleaning. Clean the unit using a cloth dampened with a mild detergent solution and then wipe dry. Avoid chemical cleaners and solvents that may damage plastic components.

Storing the GPSMAP 296

Do not store the GPSMAP 296 where prolonged exposure to temperature extremes may occur (such as in the trunk of a car) as permanent damage may result. User information, such as waypoints and routes, is retained in the unit's memory without the need for external power. It is always a good practice to back up important user data by manually recording it or downloading it to a PC (transferring it to MapSource).

Immersing the Unit in Water

The GPSMAP 296 is waterproof to IEC Standard 60529 IPX7. It can withstand immersion in 1 meter of water for 30 minutes. Prolonged submersion can cause damage to the unit. After submersion, be certain to wipe and air dry the unit before reuse or charging.

Optional Accessories

In addition to the standard accessories included with your GPSMAP 296, the optional accessories are designed to enhance the operation of the GPSMAP 296.

To obtain replacement parts and optional accessories, contact your Garmin Dealer, Garmin Product Support in the U.S.A. at 800/800.1020, or Garmin Europe at 44/0870.8501241.



WARNING: *Garmin accessories have been designed and specifically tested for use with Garmin products. Accessories offered for sale by other manufacturers have not been tested or approved for use with Garmin products. Use of such accessories could cause damage to the GPSMAP 296 and void the warranty.*

Auto Navigation Kit: Provides the parts and map data to use the GPSMAP 296 in an automobile.

GA 29, GA 29F, and GA 26C Antennas: Garmin remote antennas.

Non-Skid Friction Mount: Portable vehicle mount, no installation required.

Permanent and Temporary Adhesive Disks: Adhesive disks for using the unit in a vehicle.

External Speaker with 12/24-Volt Adapter Cable: Allows the unit to operate from the vehicle's power system through the cigarette lighter adapter. Provides a speaker for vocal prompts.

GPSMAP 296 Pilot's Guide

PC Interface Cable: Connects the unit to a serial port on your PC.

Power/Data Cable: Allows you to connect the unit to the electrical system using the bare wires.

Programmable Data Cards: Blank data cards available in a variety of sizes. Download detailed map data from MapSource CD-ROMs to a data card, either directly through your GPSMAP 296 using the included USB-PC Interface Cable, the optional PC Interface Cable (with a Serial connector), or with the optional USB Data Card Programmer.

USB Data Card Programmer: Programs blank data cards at high speed through a PC.

Carrying Case: Protects the GPSMAP 296 when not in use; with storage for data cards.

Protective Cover: Snaps on the front of the unit to protect the screen from damage.

MapSource Software CD-ROMs: Offers several detailed mapping options that are compatible with the GPSMAP 296, including City Select, BlueChart, Fishing Hot Spots, and Topo.

Pre-Programmed Data Cards: Data cards pre-programmed with either Garmin BlueChart or Fishing Hot Spots map data.

Installation Information

This section of the Appendix provides information on connecting the GPSMAP 296 to auxiliary devices and removing the antenna.

Connecting the Power/Data Cable

The power/data cable connects the GPSMAP 296 to an 11–35 VDC system and provides interface capabilities for connecting external devices. The color code in the diagram below and to the right indicates the appropriate harness connections. Replacement fuse is a 3AG - 1.5 Amp fuse.

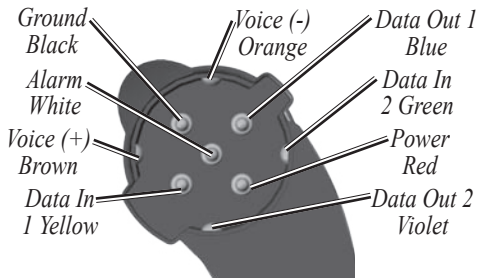

Power/Data Connector on the GPSMAP 296 Unit

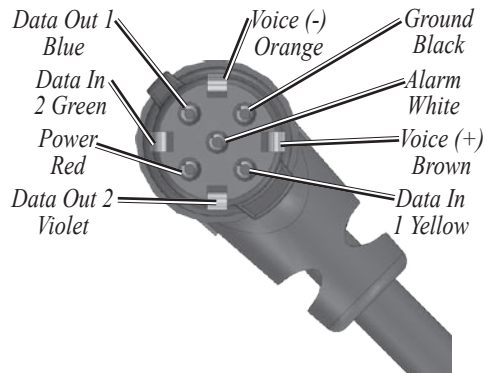

Power/Data Connector on the Cable

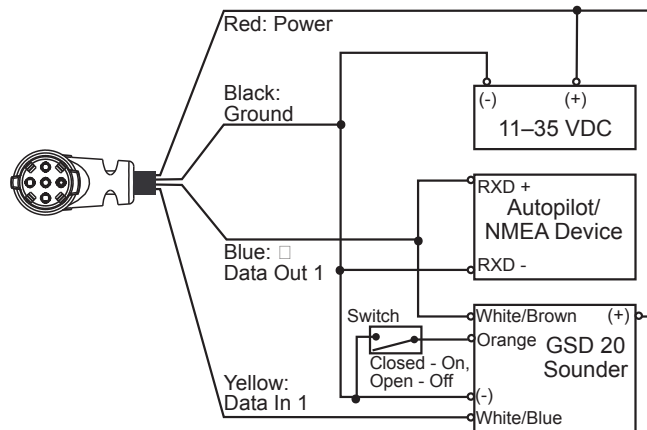

Connecting Your GPSMAP 296 to a Computer

Your GPSMAP 296 can be connected to your computer using the included USB-PC Interface Cable to connect to a USB data port or the optional PC Interface Cable to connect to a DB-9 serial communications port.



NOTE: Fully install the supplied MapSource program, Trip & Waypoint Manager, on your computer before connecting the USB cable to the computer.



USB
connector
under
weather cap

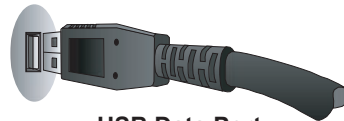

USB Data Port

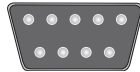

Serial Communications Port

To connect your GPS to your computer:

1. Connect the small end of your cable to the lower connector on the back of the GPSMAP 296, shown in the illustration to the left.
2. When using the supplied USB Data Cable, connect the larger end of the cable to an available USB data port (see illustration on the left).

When using a PC Interface Cable, connect the larger end of the cable to a serial communications port on your computer (see illustration on the bottom left).

Information about USB Drivers

The USB drivers should have been automatically installed when you installed the MapSource program that came with your GPSMAP 296. When you initially connect the GPSMAP 296 to a USB port, your computer may prompt you to locate the destination of the drivers for the device. You only need to install the drivers once. After the drivers are installed, your computer will always detect your GPSMAP 296 when it is connected. USB drivers may be updated periodically. You can find these updates at www.garmin.com.

Using xImage for Customized Waypoint Symbols

xImage allows you to exchange images between your PC and your GPSMAP 296. You can download and save screen shots of any screen displayed on your unit. xImage also allows you to download customizable splash screens and waypoint symbols from compatible GPS units, customize them (if you have an image editing program on your PC), and send them back to your GPS unit.

You can download xImage from the Garmin Web site at <http://www.garmin.com/ximage/>. Refer to the help file for complete instructions about using xImage.

Installing and Removing Data Cards

The GPSMAP 296 uses an optional Garmin data card to display digital charts and maps or save user data. Install the data card in the slot located on the bottom of the unit. Install or remove the data card at any time, whether the unit is on or off.

You can load a variety of information on your data card, such as BlueChart and MapSource detailed maps in a MapSource program. You can buy pre-programmed cards to use with your GPSMAP 296.

Data cards are not waterproof, should not be exposed to moisture or excessive static charges, and should be stored in the case supplied with the card.

To install a data card:

1. Insert the card into the slot on the bottom of the unit. Be sure the label is facing the front of the unit.
2. Firmly push the card into the unit. It is not necessary to force the card. The handle is still exposed when it is properly inserted.
3. If the unit is on, a confirmation tone sounds. The first time you insert a programmed data card, the unit takes a few seconds to read the card. Once the data card has been properly installed and accepted, a summary screen noting the card details appears. Press **ENTER** to acknowledge.

If you insert a data card and get a card format not recognized message, try removing the card and reinserting it. If the card is still not recognized, contact Garmin or your Garmin dealer.

To remove a data card:

1. Grasp the card handle. The handle expands for easy removal.
2. Pull the card out of the card slot on the bottom of the unit.
3. If the unit is on, a confirmation tone sounds when the data card has been removed.

Interfacing

The following formats are supported for connection of external devices: GARMIN proprietary Differential GPS (DGPS), NMEA 0180, 0182, 0183 (versions 1.5, 2.0, 2.3, 3.01), ASCII Text Output, and RTCM SC-104 input (version 2.0).

The following are the Approved Sentences for NMEA 0183, version 3.01 output: GPRMC, GPGGA, GPGSA, GPGSV, GPGLL, GPBOD, GPRTE, and GPWPL. The following are the Proprietary Sentences for NMEA 0183, version 3.01 output: PGRME, PGRMZ, and PGRMM.

The GPSMAP 296 also includes NMEA input with support for the BWC, DBT, DPT, MTW, VHW, VTG, and XTE sentences.

Garmin's proprietary communication protocol is available from the Web site (www.garmin.com).

Removing the Antenna

You can remove the antenna to use an external antenna. After the antenna is removed, the BNC connector is exposed and ready for use with an external antenna. For information on connecting an external antenna to the GPSMAP 296, refer to the installation instructions that came with the antenna.

To remove the antenna:

1. Remove the external power cable from the connector on the back of the GPSMAP 296.
2. Rotate the antenna to approximately a seven o'clock position. The alignment notches in the casing must line up with the notches on the antenna.
3. Pull the antenna away from the GPSMAP 296 unit.

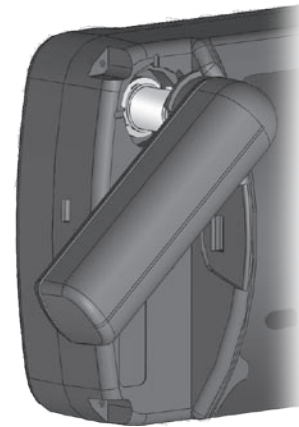

Removing the Antenna

Learning about GPS

The Global Positioning System (GPS) is a satellite-based navigation system made up of a network of 24 satellites placed into orbit by the United States Department of Defense.

GPS was originally intended for military applications, but in the 1980s, the government made the system available for civilian use. GPS works in any weather conditions, anywhere in the world, 24 hours a day. There are no subscription fees or setup charges to use GPS. For more information refer to the Garmin Web site at www.garmin.com and also read the *GPS Guide for Beginners*, which can be found on the Web site at <http://www.garmin.com/aboutGPS/manual.html>.

Common GPS Terms

Initialize—the first time a GPS receiver orients itself to its current location and collects data. After the receiver is initialized, it remembers its location and acquires a position more quickly.

Position—an exact, unique location based on geographic coordinates (Latitude and Longitude).

Route—A group of waypoints entered into the GPS receiver in the sequence you desire to navigate them.

Waypoint—a location you store in your GPS. It may be a checkpoint on a route or a significant ground feature, such as your campsite or favorite fishing spot.

What is Differential GPS (DGPS)?

The United States and Canadian governments (among others) have set up Differential GPS (DGPS) stations to transmit correction signals. They are operational in coastal areas and on many navigable river systems.

The DGPS system is available for use without a fee, but you do need additional equipment to receive DGPS signals: A beacon receiver compatible with the RTCM format sentences supported by your Garmin GPS is needed to use DGPS.

Refer to the United States Coast Guard's Web site (<http://www.navcen.uscg.gov/>) for locations and status of the differential stations.

Differential Field

Differential receiver status is indicated in the bottom left field of the GPS page and will show one of the following conditions:

- **None:** No optional beacon receiver is attached or enabled in the Com 1 or 2 tab of the Main Menu or WAAS is turned Off.
- **Searching for WAAS:** WAAS is enabled and the receiver is searching for WAAS signal.

- **Using WAAS:** WAAS capability is enabled and the unit is receiving WAAS corrections.
- **Check Beacon Wiring:** The DGPS setting is enabled in the Com 1 or 2 tab of the Main Menu but no DGPS device is detected.
- **No Beacon Signal:** DGPS receiver is attached, but not transmitting RTCM data to GPS.
- **Tuning Beacon:** The receiver is tuning manually to a DGPS frequency.
- **Using Differential:** The unit is receiving DGPS corrections.
- **Scanning for Beacon:** The DGPS receiver is scanning for an available frequency.

What is WAAS?

The Wide Area Augmentation System (WAAS) is an FAA-funded project to improve the overall integrity of the GPS signal and increase position accuracy for users in North America.

The system is made up of satellites and approximately twenty-five ground reference stations positioned across the United States that monitor GPS satellite data. Two master stations, located on either coast, collect data from the reference stations and create a GPS data correction message.

According to the FAA's Web site, testing in September 2002 of WAAS confirmed an accuracy performance of 1–2 meters horizontal and 2–3 meters vertical throughout the majority of the continental United States and portions of Alaska.

WAAS is just one service provider that adheres to the MOPS (Minimum Operational Performance Standard) for global Satellite Based Augmentation Systems (SBAS). Eventually, there will be several services of worldwide geostationary communication satellites and ground reference stations.

All SBAS systems use the same receiver frequency; therefore, any operational SBAS system should be capable of providing your GPS unit with increased accuracy at any location in the world.

Currently, enabling WAAS on your Garmin GPSMAP 296 in regions that are not supported by ground stations may not improve accuracy, even when receiving signals from an SBAS satellite. In fact it can degrade the accuracy to less than that provided by GPS satellites alone. For this reason, when you enable WAAS on your Garmin GPS receiver, the receiver automatically uses the method that achieves the best accuracy. To enable WAAS, refer to page 6.

For more information, go to <http://gps.faa.gov/Programs/WAAS/waas.htm>.

LORAN TD Setup

LORAN C is a radio navigation aid operated and maintained in the United States by the United States Coast Guard. The name LORAN is an acronym for “LOng RANGE Navigation.” The LORAN system covers the entire United States and the United States Coastal Confluence Zone. From the perspective of a mariner, the system is used for ocean and coastal navigation. It can be used as a supplemental system for harbor and harbor approach navigation, and it is used for inland navigation by recreational vehicles.

LORAN TD Feature

The LORAN TD (Time Delay) feature eases the transition from using LORAN to using GPS. The GPSMAP unit automatically converts GPS coordinates to LORAN TDs for those who have a collection of LORAN fixes for favorite fishing spots and other waypoints recorded as TDs. You can display your position as a TD or enter waypoints as TDs. The accuracy to be expected from this conversion is approximately thirty (30) meters. When the unit is placed in the LORAN TD format mode, it simulates the operation of a LORAN receiver. Position coordinates may be displayed as TDs, and all navigation functions may be used as if the unit was actually receiving LORAN signals.

Using the LORAN TD Format

When creating new waypoints using LORAN TD coordinates, you must set the correct LORAN chain number and secondary stations in the Setup TD field before storing the waypoint. After the waypoint is stored in unit memory, it will always reference the LORAN chain number and secondary stations currently selected in the Setup TD field. If you enter a different LORAN chain number, or change the secondary stations or offsets in the Setup TD field, the active waypoint information will reflect those changes. Since the GPSMAP 296 does not rely on the LORAN signal for navigation, it can reference a different GRI chain and/or secondary stations and still navigate to the location stored in memory.

The LORAN Position Format field is located under the Units tab in the Main Menu. The LORAN TD Setup window contains the fields to select the Loran GRI-Chain Number, Primary and Secondary Stations, and TD Offsets.

To set up Loran TD from the Main Menu:

1. Press **MENU** twice to display the Main Menu.
2. Use the **Rocker** key to highlight Setup on the vertical tab list. Then select **Location** from the row of horizontal tabs.
3. Using the **Rocker** key, highlight the **Location Format** field and press **ENTER**.



Location Tab of the Setup Tab

4. Highlight **Loran TD**, press **ENTER**.
5. Highlight the **Setup** button located on the right side of the **Location Format** field and press **ENTER**. The Loran TD Setup window appears.
6. To change the settings of any of the five fields, highlight the field, press **ENTER**, enter the desired setting using the **Rocker** key, then press **ENTER**.



LORAN TD Setup

7. When done, highlight the **Save** button and press **ENTER**.

If the active GRI Chain, secondary stations, or offsets have been changed since the waypoint was created, the waypoint will now reference the active GRI chain and secondary stations and adjust the TD coordinates accordingly. Remember that the GPS is not relying on the LORAN signal for navigation and actually converts the TD coordinate to a useful latitude and longitude coordinate before storing the waypoint to memory or using it for navigation. Because of this, the unit can navigate to a TD coordinate anywhere in the world.

You must know your GRI chain number and/or secondary stations to create a LORAN TD position. For more information please read our LORAN TD Position Format Handbook, available at the Garmin Web site, at www.garmin.com/support/userManual.html.

Map Datums and Location Formats

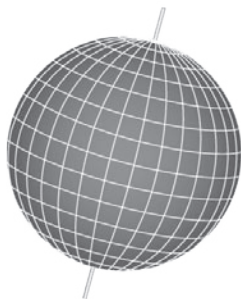

Map Datums are based on a mathematical model of the Earth.

What are Map Datums and which should I use?

A datum is a mathematical model of the Earth that approximates the shape of the Earth and enables calculations to be carried out in a consistent and accurate manner. The datum is physically represented by a framework of ground monuments (such as trig. stations) whose positions have been accurately measured and calculated on this reference surface. Lines of latitude and longitude on a map or chart are referenced to a specific map datum. Every chart has a map datum reference and the GPSMAP 296 can be set to match most of those commonly used.

If you are navigating and comparing the GPS coordinates to a map, chart, or other reference, the map datum in the GPS unit should be set to the same datum as the map to ensure the most accurate navigation.

What is a Location Format and which should I use?

Your current location can be viewed on the GPS in the form of coordinates. Since different maps and charts use different location formats, Garmin GPS units allow you to choose the correct coordinate system for the type of map you are using. The most common format is latitude and longitude, which is utilized by all Garmin units. You may choose to change the location format to use with other coordinate systems in Location Preferences. UTM/UPS (Universal Transverse Mercator/Universal Polar Stereographic) are easy-to-use metric grids that are found on most USGS topographic quadrangle maps. Several other grids, including a user-definable grid (for the advanced user), may also be selected.

For more information about using paper maps with your Garmin unit, refer to *Using a Garmin GPS with Paper Land Maps*, available for download at http://www.garmin.com/manuals/UsingaGarminGPSwithPaperLandMaps_Manual.pdf.

Digital Selective Calling (DSC)

Digital Selective Calling (DSC) uses marine VHF radio and Global Positioning System (GPS) technologies to transmit and receive location information. DSC is used by mariners to assist them in two major areas: Distress Calls and Position Reporting.

A non-emergency DSC Position Report allows mariners to exchange and display the positions of one another. When you receive a DSC position, you can create a waypoint or to show the received position on an electronic map.

An emergency DSC Distress Call allows a vessel in trouble to transmit a substantial amount of information in a single transmission or “call,” without the need for voice communication. When any nearby rescuer receives the DSC signal, an alarm sounds and they immediately receive the position of the caller.

The rescuer may then choose to navigate (Go To) the caller’s position to assist or forward the call on to the Coast Guard. When the Coast Guard receives the call, they can immediately access the caller’s information (such as who they are and the type of vessel) in their database while they are in transit to the caller’s position.

Any time a vessel receives a DSC call, they can store that location and quickly navigate to that position using a Go To. This makes DSC a time-saver, especially in an emergency situation. In order to

use DSC, users must first register their VHF radio with the FCC and receive a Maritime Mobile Service Identity (MMSI) number.

What is a Maritime Mobile Service Identity (MMSI)?

Maritime Mobile Service Identity (MMSI) basically allows a VHF radio to act like a phone. The 9-digit MMSI number acts like a phone number when used in a Position Report and as a unique identifier to the Coast Guard when used in an emergency Distress Call. To obtain a Maritime Mobile Service Identity (MMSI) number, users must register their VHF radio with the FCC (Form 605).

Garmin does not supply this number!

For more information regarding MMSI’s visit <http://www.navcen.uscg.gov/marcomms/gmdss/mmsi.htm>.

How are MMSI assignments obtained?

Non-commercial users, such as recreational users, who remain in United States waters and only carry VHF, EPIRB (Emergency Position Indicating Radio Beacons), and Radar are not required to have a FCC ship station license. The FCC and Coast Guard have authorized some second and third party vendors to assign MMSI numbers. This service is limited to registering recreational vessels only. To receive information on how to obtain a recreational MMSI number contact <http://www.uscg.mil/rescue21/links/mmsi.htm> or <http://wireless.fcc.gov/marine/>.

United States Non-Federal User

Commercial users, or those who travel outside the United States or Canada, must apply for a ship station license or an amendment to a ship station license. To find out if you require a Ship Station license contact <http://wireless.fcc.gov/marine/fctsht14.html>. If your vessel requires licensing by the FCC you will obtain a MMSI during the application/licensing process when you file FCC Forms 159 and 605.

United States Federal User

Federal users can obtain MMSI assignments from their agency radio spectrum management office. These procedures are currently under review by the National Telecommunications and Information Administration (NTIA).

User Outside the United States

Users can obtain an MMSI assignment from their telecommunications authority or ship registry, often by obtaining or amending their ship station license.

User In Canada

Industry Canada is responsible for assigning MMSI numbers to commercial and recreational vessels. Information is available at the following Web site: <http://apollo.ic.gc.ca/english/mmsi.html>.

How can Garmin help you with DSC?

To receive Distress Calls or Position Reports, you must have a DSC-equipped chartplotter as well as a VHF radio with DSC support. During normal, non-emergency Position Report communication, Channel 70 (156.525 MHz) has been set aside as the VHF/DSC digital call channel.

For a Distress Call, press the MayDay button on the VHF radio. The call transmits on an emergency channel with the MMSI number attached to the call, if the receiver has DSC support. Any DSC-equipped mariner (on sea or land) within range can receive the call.

When the Garmin GPSMAP 296 is connected to a VHF with DSC support, the GPS unit displays a Call List, Log, and a Directory. Basic wiring is required for the Garmin unit and VHF radio to send and receive NMEA data from each other.

Jeppesen Database Information

The GPSMAP 296 includes an internal Jeppesen® database that provides position and facility information for thousands of airports, VORs, NDBs, and more. Updates to the Jeppesen database are available every 28 days online (www.garmin.com). The update program is designed to operate on Windows®-compatible PCs and requires the included PC Interface Cable to connect your GPSMAP 296 to the PC's serial communications port. The following information is provided from the internal Jeppesen database:

Airport—* identifier, facility name, city/state/country, latitude/longitude, field elevation, available fuel types, runway designations and layout, runway surface, runway length, runway width, runway lighting, communication frequencies, and published approaches.

Weather—associated with an airport (ASOS, ATIS, and AWOS).

VORs—* identifier, facility name, city/state/country, position (latitude/longitude), frequency, service volume (high, low, terminal), and type (such as VOR-DME, TACAN, and VORTAC).

NDBs—* identifier, facility name, city/state/country, position (latitude/longitude), and frequency.

Intersections—identifier, nearest VOR, radial and distance from nearest VOR, position (latitude/longitude), and region/country.

ARTCC—Air Route Traffic Control Centers.

Airspace—boundaries (Class B, Class C, Control Zones, SUAs, and MOAs), controlling agency, and vertical boundaries.

FSS—Flight Service Stations.

* Symbology used for NDBs, VORs, and airports are consistent with those used on a sectional chart.

Database Updates

Updates to the Jeppesen database are available every 28 days online (<http://shop.garmin.com/aviation/databases/>). The update programs are designed to operate on Windows®-compatible PCs and requires the included USB Interface Cable to be connected to the unit and an available USB port on your computer.



NOTE: After you perform an update to your Jeppesen Database, verify that all of your flight plans (routes) in your unit are still current. If there is an obsolete Jeppesen aviation point in a saved route, the route will be locked and unusable. You need to create a new route with current Jeppesen Database points.

An optional FlightBook software package is available to assist with your flight record keeping. Visit the Garmin Web site at <http://www.garmin.com/aviation>.

Messages

Approaching Turn: You are nearing a turn in a route.

Approaching VNAV Profile: You should reach your initial descent point in one minute.

Arriving at Destination: You are nearing your destination.

Batteries Low: The battery needs to be recharged.

Can't Unlock Maps: No applicable unlock code for one or more maps was found. All MapSource maps are not accessible.

Database Error: Internal problem with the unit. Contact your dealer or Garmin Product Support to have the unit repaired.

Deep Water: The water is deeper than the amount set in the Deep Water Alarm.

Dragging Anchor: The distance set in the Anchor Drag Alarm is exceeded.

Lost Satellite Reception: The unit is unable to receive satellite signals.

Memory Full: Unit memory is full, no further data can be saved.

Near Proximity Point: You have reached the distance set for a proximity waypoint.

No Diff GPS Location: RTCM is selected but the unit is not receiving DGPS data.

None Found: No data matched the search criteria.

No Tide Stations for that Area: No tide stations within 100 miles of the area.

Off Course: You are off course the distance set in the Off Course Alarm.

Proximity Memory Full: No additional proximity waypoints can be saved.

Proximity Radius Overlaps: The radius of two proximity waypoints overlap.

Route Already Exists: You have entered a route name that already exists.

Route Memory Full: No additional routes can be saved.

Route Truncated: Uploaded route from another device has more than 50 waypoints.

Route Waypoint Memory Full: No additional route waypoints can be saved.

Shallow Water: The water is shallower than the amount set in the Shallow Water Alarm.

Track Already Exists: A saved track with the same name already exists.

Track Log Full: The track log is full and track recording has been turned off. In order to record more track points, you will need to clear the track log and turn track recording on.

Track Memory Full: No more track data can be stored. Delete the old track data to store the new data.

Track Truncated: A complete uploaded track will not fit in memory. The oldest track log points have been deleted.

Transfer Complete: Data transfer has been completed.

Waypoint Already Exists: A waypoint with the same name already exists.

Waypoint Memory Full: The unit has stored the maximum number of waypoints.

Data Field Options

The following list provides a brief description of each data field option. Some of these options are supported only by devices interfaced to your GPSMAP 296.

Accuracy: The current accuracy of your GPS determined location.

Altitude: (Aviation Only) Height above mean sea level (MSL).

Battery Timer: The time remaining on the battery before it is fully discharged.

Bearing: The compass direction from your current location to a destination.

Course: The desired path of travel from your starting location to a destination.

Course to Steer: The recommended direction to steer in order to reduce cross-track error and return to the course line. Displayed as **Steer**.

Cross Track: The distance you are off a desired course in either direction, left or right.

Depth: (Marine Only) The depth of water from sonar NMEA input.

Dest Wpt: See **Waypoint (Destination)** on the next page.

Distance (Destination): The entire distance, from beginning to end, of a route.

Distance (Next): The distance to the next point on a route.

ETA (Destination): Estimated Time of Arrival. The estimated time you will reach your destination.

ETA (Next): Estimated Time of Arrival. The estimated time you will reach the next point on your route.

ETE (Destination): Estimated Time Enroute. The estimated time required to reach your destination.

ETE (Next): Estimated Time Enroute. The estimated time required to reach the next point on your route.

Est. Time to VNAV: (Aviation Only) The estimated time required to reach the initial descent point in a VNAV profile. Displayed as **Time to VNAV**.

Elevation: (Marine and Automotive Only) The altitude (height) above or below mean sea level (MSL).

Flight Timer: (Aviation Only) The length of time for the current flight.

Fuel Timer: (Aviation Only) The fuel required to travel from current location to the indicated route waypoint.

GPS Status: The current status of the GPS receiver, such as “3D GPS.”

Glide Ratio: (Aviation Only) The ratio of horizontal distance traveled to vertical distance. For example, a 6:1 glide ratio indicates a 1000 vertical descent for every 6000 horizontal distance travelled.

Glide Ratio to Target: (Aviation Only) The glide ratio required to descend from present position and altitude to the target altitude at the location specified in the VNAV setup.

Location (Lat/Lon): Your current location as latitude/longitude coordinates.

Location (Selected): Your current location described in the selected units of measure (other than lat/lon).

Max Speed: The maximum speed the unit has moved since last reset.

Mov Avg Spd: See **Trip Avg. Speed (Moving)** on the next page.

Move Timer: See **Trip Timer (Moving)** on the next page.

Next Course: The remaining distance of the route.

Next Turn: The remaining distance to the next waypoint on the route.

Next Wpt: See **Waypoint (Next)**.

Odometer: The total distance traveled since the Odometer was reset.

Pointer: The arrow indicating the direction to travel to the next point on a route.

Power: The power indicator icon: Battery, External Power, or Charging.

Speed: Your current vehicle speed can be measured in miles per hour, kilometers per hour, or knots.

Steer: See **Course to Steer** on the previous page.

Sunrise: The time at which the sun rises on this day.

Sunset: The time at which the sun sets on this day.

Time: The current time and date. It can be displayed in 12-hour or 24-hour format in local time or universal (UTC) time.

Time to VNAV: See **Est. Time to VNAV** on the previous page.

Track: The direction of movement relative to a ground position. Also referred to as ground track.

Trip Avg. Speed (Moving): The average speed while moving since the last reset of the Trip Computer. Displayed as **Mov Avg Spd**.

Trip Avg. Speed (Total): The total average speed traveled since the last reset of the Trip Computer. Displayed as **Ttl Avg Spd**.

Trip Odometer: The total distance traveled since the Trip Computer was reset.

Trip Timer (Moving): The length of time your vehicle has been in motion, since the Trip Computer was reset. Displayed as **Move Timer**.

Trip Timer (Total): The total time the unit has been tracking since the Trip Computer was reset.

Ttl Avg Spd: See **Trip Avg. Speed (Total)**.

Turn: The direction of, and distance to, the next turn on an active route.

User Timer: The timer you set in the Main Menu.

Velocity Made Good: The rate of closure on a destination based upon your current speed and course of travel. Displayed as **VMG**.

Vert Speed To Target: (Aviation Only) The measurement of your rate of ascent/descent to a predetermined altitude. Displayed as **VS to Target**.

Vertical Speed: The rate of climb or descent.

Voltage: The direct current voltage level of an external power source.

Water Speed: (Marine Only) The data acquired from measurement devices interfaced to the unit is used to calculate your current speed over water.

Water Temperature: (Marine Only) The temperature of water at a measured depth using measurement devices interfaced to the unit.

Waypoint (Destination): The last point on a route, your destination. Displayed as **Dest Wpt**.

Waypoint (Next): The next waypoint in your route. Displayed as **Next Wpt**.

Safety and Product Information

This section of the Appendix contains information about your license agreement and warranty, as well as compliance information. Read the Safety Information to learn how to properly and safely operate the GPSMAP 296.

Software License Agreement

BY USING THE GPSMAP 296, YOU AGREE TO BE BOUND BY THE TERMS AND CONDITIONS OF THE FOLLOWING SOFTWARE LICENSE AGREEMENT. PLEASE READ THIS AGREEMENT CAREFULLY.

Garmin grants you a limited license to use the software embedded in this device (the “Software”) in binary executable form in the normal operation of the product. Title, ownership rights, and intellectual property rights in and to the Software remain with Garmin.

You acknowledge that the Software is the property of Garmin and is protected under the United States of America copyright laws and international copyright treaties. You further acknowledge that the structure, organization, and code of the Software are valuable trade secrets of Garmin and that the Software in source code form remains a valuable trade secret of Garmin. You agree not to decompile, disassemble, modify, reverse assemble, reverse engineer, or reduce to human readable form the Software or any part thereof or create any derivative works based on the Software. You agree not to export or re-export the Software to any country in violation of the export control laws of the United States of America.

Product Registration

Help us better support you by completing our online registration today! Have the serial number of your GPSMAP 296 handy and connect to our Web site (www.garmin.com). Look for the Product Registration link on our Home page.

Use this area to record the serial number (8-digit number located on the back of the box) in case your GPSMAP 296 is lost, stolen, or needs service. Keep your original sales receipt in a safe place or attach a photocopy inside the manual.

Serial Number:

Contact Garmin

If you should encounter any difficulty while using your GPS unit, or if you have any questions, in the U.S.A. contact Garmin Product Support by phone: 913/397.8200 or 800/800.1020, Monday–Friday, 8 AM–5 PM Central Time; or by e-mail at sales@garmin.com. In Europe, contact Garmin (Europe) Ltd. at 44/0870.8501241.

Limited Warranty

This Garmin product is warranted to be free from defects in materials or workmanship for one year from the date of purchase. Within this period, Garmin will at its sole option repair or replace any components that fail in normal use. Such repairs or replacement will be made at no charge to the customer for parts or labor, provided that the customer shall be responsible for any transportation cost. This warranty does not cover failures due to abuse, misuse, accident, or unauthorized alteration or repairs.

THE WARRANTIES AND REMEDIES CONTAINED HEREIN ARE EXCLUSIVE AND IN LIEU OF ALL OTHER WARRANTIES EXPRESS OR IMPLIED OR STATUTORY, INCLUDING ANY LIABILITY ARISING UNDER ANY WARRANTY OF MERCHANTABILITY OR FITNESS FOR A PARTICULAR PURPOSE, STATUTORY OR OTHERWISE. THIS WARRANTY GIVES YOU SPECIFIC LEGAL RIGHTS, WHICH MAY VARY FROM STATE TO STATE.

IN NO EVENT SHALL GARMIN BE LIABLE FOR ANY INCIDENTAL, SPECIAL, INDIRECT OR CONSEQUENTIAL DAMAGES, WHETHER RESULTING FROM THE USE, MISUSE, OR INABILITY TO USE THIS PRODUCT OR FROM DEFECTS IN THE PRODUCT. Some states do not allow the exclusion of incidental or consequential damages, so the above limitations may not apply to you.

Garmin retains the exclusive right to repair or replace the unit or software or offer a full refund of the purchase price at its sole discretion. SUCH REMEDY SHALL BE YOUR SOLE AND EXCLUSIVE REMEDY FOR ANY BREACH OF WARRANTY.

Products sold through online auctions are not eligible for rebates or other special offers from Garmin. Online auction confirmations are not accepted for warranty verification. To obtain warranty service, an original or copy of the sales receipt from the original retailer is required. Garmin will not replace missing components from any package purchased through an online auction.

To obtain warranty service, contact your local Garmin authorized dealer or call Garmin Product Support for shipping instructions and an RMA tracking number. The unit should be securely packed with the tracking number clearly written on the outside of the package. The unit should then be sent, freight charges prepaid, to any Garmin warranty service station. A copy of the original sales receipt is required as the proof of purchase for warranty repairs.

Garmin International, Inc.

1200 E 151st Street, Olathe, Kansas 66062 U.S.A.

Tel. 913/397.8200

Fax. 913/397.8282

Garmin (Europe) Ltd.

Unit 5, The Quadrangle, Abbey Park Industrial Estate,

Romsey, SO51 9DL U.K.

Tel. 44/0870.8501241

Fax 44/0870.8501251

The Garmin GPSMAP 296 has no user-serviceable parts. Should you ever encounter a problem with your unit, please take it to an authorized Garmin dealer for repairs.

The GPSMAP 296 is fastened shut with screws. Any attempt to open the case to change or modify the unit in any way will void your warranty and may result in permanent damage to the equipment.

FCC Compliance

The GPSMAP 296 complies with Part 15 of the FCC interference limits for Class B digital devices FOR HOME OR OFFICE USE. These limits are designed to provide more reasonable protection against harmful interference in a residential installation, and are more stringent than “outdoor” requirements.

Operation of this device is subject to the following conditions: (1) This device may not cause harmful interference, and (2) this device must accept any interference received, including interference that may cause undesired operation.

This equipment generates, uses, and can radiate radio frequency energy and may cause harmful interference to radio communications if not installed and used in accordance with the instructions. However, there is no guarantee that interference will not occur in a particular installation. If this equipment does cause harmful interference to radio or television reception, which can be determined by turning the equipment off and on, the user is encouraged to try to correct the interference by one of the following measures:

- Reorient or relocate the receiving antenna.
- Increase the separation between the equipment and the receiver.
- Connect the equipment into an outlet on a circuit different from that to which the receiver is connected.
- Consult the dealer or an experienced radio/TV technician for help.

The GPSMAP 296 does not contain any user-serviceable parts. Repairs should only be made by an authorized Garmin service center. Unauthorized repairs or modifications could result in permanent damage to the equipment and void your warranty and your authority to operate this device under Part 15 regulations.

Safety Information

WARNING: The GPSMAP 296 contains a lithium-ion rechargeable battery. The battery used in this device may present a risk of fire or chemical burn if mistreated. Do not recharge out of the unit, disassemble, heat above 140°F (60°C), or incinerate.

WARNING: If original battery must be removed for replacement, dispose of used battery properly. Contact your local waste disposal department for information on proper disposal of lithium-ion batteries. Keep used battery away from children. Do not disassemble and do not dispose of in fire.

WARNING: Only replace with Garmin Lithium-Ion Battery Pack (Garmin Part Number 010-10517-00). Use of another battery may present a risk of fire or explosion.

WARNING: This product, its packaging, and its components contain chemicals known to the State of California to cause cancer, birth defects, or reproductive harm. This Notice is being provided in accordance with California's Proposition 65. If you have any questions or would like additional information, please refer to our Web site at <http://www.garmin.com/prop65>.

WARNING: For VFR use only as an aid to prudent navigation. All information is presented for reference only. You assume total responsibility and risk associated with using this device. Terrain and obstacle data are provided only as an aid to situational awareness.

CAUTION: Use the GPSMAP 296 at your own risk. To reduce the risk of unsafe operation, carefully review and understand all aspects of this *Pilot's Guide*—and thoroughly practice operation using Simulator Mode prior to actual use. When in actual use, carefully compare indications from the GPSMAP 296 to all available navigation sources, including information from other NAVAIDs, visual sightings, charts, etc. For safety, always resolve any discrepancies before continuing navigation.

CAUTION: IT IS THE USER'S RESPONSIBILITY TO USE THIS PRODUCT PRUDENTLY. THIS PRODUCT IS INTENDED TO BE USED ONLY AS A NAVIGATIONAL AID AND MUST NOT BE USED FOR ANY PURPOSE REQUIRING PRECISE MEASUREMENT OF DIRECTION, DISTANCE, LOCATION, OR TOPOGRAPHY. THIS PRODUCT SHOULD NOT BE USED TO DETERMINE GROUND PROXIMITY FOR AIRCRAFT NAVIGATION.

CAUTION: The electronic chart is an aid to navigation and is designed to facilitate the use of authorized government charts, not replace them. Only official government charts and notices to mariners contain all information needed for safe navigation—and, as always, the user is responsible for their prudent use.

WARNING: The Global Positioning System (GPS) is operated by the United States government, which is solely responsible for its accuracy and maintenance. The system is subject to changes which could affect the accuracy and performance of all GPS equipment. Although the Garmin GPSMAP 296 is a precision electronic NAVigation AID (NAVAID), any NAVAID can be misused or misinterpreted, and therefore become unsafe.

MAP DATA INFORMATION: One of the goals of Garmin is to provide customers with the most complete and accurate cartography available, at a reasonable cost. We use a combination of governmental and private data sources, which we identify as required in product literature and copyright messages displayed. Virtually all data sources contain inaccurate or incomplete data to some degree. This is particularly true outside the United States, where complete and accurate digital data is either not available or prohibitively expensive.

Because the Garmin GPSMAP 296 can be used for vehicular navigation, important safety considerations must be followed. Please read and observe the following instructions.

WARNING: For use in vehicles, it is the sole responsibility of the owner/operator of a vehicle to place and secure the GPSMAP 296 so it will not interfere with the vehicle operating controls and safety devices, obstruct the driver's view of driving conditions, or cause or personal injury in the event of an accident.

Do not mount the unit over airbag panels or in the field of airbag deployment. Airbags expand with a rapid force that can propel objects in their path towards the driver or passengers, causing possible injury. Refer to airbag safety precautions in the vehicle owner's manual.

Do not mount the unit in a place where the driver or passengers are likely to impact it in a collision. The mounting hardware provided by Garmin is not warranted against collision damage or the consequences thereof.

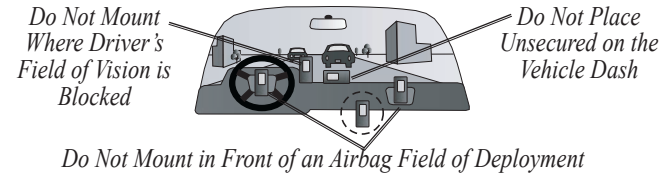

WARNING: When used in vehicles, it is the sole responsibility of the driver of the vehicle to operate the vehicle in a safe manner, maintain full surveillance of all driving conditions at all times, and not become distracted by the unit to the exclusion of safe driving practices. It is unsafe to operate the controls of the unit while you are driving. The driver of a vehicle equipped with a GPSMAP 296 must pay full attention to operation of the vehicle and road conditions while the vehicle is in motion. Failure to pay full attention could result in an accident with property damage and personal injury.

INDEX

Symbols

2D 5, 57, 126

3D 5, 57, 145

A

Accessories 131

Acquiring Satellites 5

Activate

Go To 51

Route 71

Simulator 11

Active Route Page

Aviation Mode 42

Active Track Tab 81, 84

AC Outlet 2

Add to Route 55, 57, 62, 70, 74

Advanced NMEA Output Setup 117

Aircraft Information 45–46

Airport 18, 143

Criteria 22

Identifier 6, 11, 15

Information 16, 17, 19

Airspace 32

Alarms 94, 95

Alert 21, 28

Boundary 29, 32

Information 20, 21, 32

Nearest 18
Alarms 28, 94, 108

Airspace 95

Anchor Drag 95

Arrival 95

Depth 96

Descent Rate 35, 36

DSC 90, 93

Fish 96

Next Turn 95

Obstacle 35, 36

Off Course 95

Persistent 94

Pop-up 36

Proximity 80

Sonar 96

System 96

Terrain 35, 36

Terrain Page Setup 37

VNAV 40

Alarms Tab 94

Airspace Alarms 95

Navigation 95

Sonar Alarms 96

System Alarms 96

Alerts. *See* Alarms

Altitude 38, 110

Antenna 1, 3, 135

Append to Route 74

Approach 17, 23, 24, 42

Arrow Key 7

ARTCC 18

Ask Me My Preference 112

Assign Category 77

Asterisk (*) 17

AutoLocate 3, 5

Average Location 74

Avoids 61, 113

B

Backlight 3, 107

Baro Pressure 48

Battery

Level 4

Pack 1, 2

Saver Mode 109

Beeper 108

BlueChart 134

Bug Heading 39

Bug Indicator 88

Setting 34

C

Cable 132

Calculate Routes for 113

Calculation Method 112

Calendar 97

Calibrated Airspeed 48

Calibrate Water Speed 124

Cards, Data 134

Care Information 131

Carpool Lanes 113

Categories

Find Menu 52

Waypoint 76

CDI. *See* Course Deviation Indicator

Celestial Information 98–101

Celestial Tab

Hunt & Fish Tab 101

Sun & Moon Tab 98

Tide Tab 99

Charging 2, 4

Check Beacon Wiring 137

Cigarette Lighter Adapter 2

Cleaning 130

Clear Map Display 33

Clear Track Log 82

Clock Alarm 96

Coast Guard 141, 142

Code. *See* Airport Identifier

Color Mode 107

Communication Frequencies 20

Comm Usage Restrictions 17

Compass Page 49, 89, 107

Marine Mode 88–89

Options Menu 88

COM 1 and COM 2 Tabs 115–117

Connecting the Power Cable 2, 132

Contact Garmin 147

Course Deviation Indicator 24, 38,

39, 88
 Course Deviation Scale 38, 39
 Course Pointer 88
 Course to Steer 34
 Create
 Category 76
 Flight Plan 27
 Route 55, 56
 Waypoint. *See* Marking a Waypoint
 Creating a Direct To 15–17
 Criteria 22
 Cruising Speed 45
 Current Route Page 60
 Automotive Mode 66
 Custom Avoids 61, 113

D
 Dashboard 67
 Data Card 30, 134
 Information 54, 106
 Slot 1
 Data Fields 105, 145
 Data Field Options 145–146
 Data Format 115–117
 Date 111
 Daylight Saving Time 111
 DB-9 133
 Declutter 33
 Defaults 8, 105, 111
 Delete

Aircraft Profile 46
 Category 76
 DSC Call 91
 DSC Directory Item 92
 Flight Records 44
 Route 68
 Track Log 82
 Waypoint 78, 79
 Waypoint Category 76
 Density Altitude 48
 Depth 110
 Descent Rate Alert 28
 Detailed Maps 10, 30, 106, 134
 Details 16, 17, 19
 Detour 62
 DGPS 116, 117, 136
 Alarm 96
 Differential 137
 Differential Field 136
 Differential GPS 136
 Digital Selective Calling. *See* DSC
 Direction Display 110
 Direct To 15, 19
 Display 1
 Display Tab 107
 Distance and Speed 110
 Distress Calls 90–93, 141–142
 Drift Alarm 96
 DSC 90–93, 141–142

E
 E6B 47–48
 Edit
 Route 69, 70, 71
 Waypoints 72, 73
 Elevation 110
 Emergency
 Aviation 19
 Marine 141
 Entering Data 9, 10
 Erase. *See* Delete
 External Power Source 4
 External Voltage Alarm
 96
F
 Faster Time 112
 FCC 141, 142, 149
 Field 8
 Find
 From 52
 From a Different Location 52, 53
 Menu 51, 54
 Your Current Location 3
 Finding an Item in Automotive or
 Marine Mode 52–54
 Finding a Nearby Aviation Point
 18–22
 Fishing Information 101
 Fish Symbols 123

Flasher 125
 FlightBook 44, 143
 Flight Log 44
 Flight Plan 27
 Create 27
 Follow 28
 Locked 27
 Following an Automotive Route 60
 Following your Flight Plan 28
 Follow Roads 56
 FSS 18
 Fuel Flow 42, 45, 71

G
 GARMIN DGPS 115, 116
 Getting Satellite Signals 4–6
 Going to a Destination 50
 Go To 15, 16, 78
 Distress Call 92
 History 53
 Page 16, 23
 Point 86
 Position Report 92
 GPS 136–137
 Learning About 136
 Off/On 5
 Page 6, 68
 GRI Chain 139
 GSD 20 118
 Guidance Tab 113

H

- Heading 114
- Highways
 - Avoid 113
- Highway Page 107
 - Automotive Mode 64–65
 - Data Fields 65
 - Page Layout 65
 - Setup 65
- HSI 38
 - Bug Indicator 34
- Hunt & Fish Tab 101

I

- Icons 107
- Identifier 6, 11, 12, 15, 18, 141, 143
- Information Page 32, 54
- Initialize 3, 136
- Installation Information 132–135
- Intersection 143
- IN Key 7

J

- Jeppesen Database 27, 143
 - Updates 10

K

- Keypad 7

L

- Land at Closest Point 19

- Language 108, 109
- Learning about GPS 136–137
- Legs, Track 84
- Limited Warranty 148
- Lithium-ion 1, 2, 149
- Local Time 111
- Location 6, 59
- Location Format 114, 140
- Locked Route 27
- Log Filter 102
- Longitude 145
- LORAN TD Setup 138–139
- Lost Satellite Reception 5

M

- Magnetic Variation 114
- Main Menu
 - Alarms Tab 94
 - Display Tab 107
 - GPS Tab 4
 - Sound Tab 108
- Main Menu Overview 94–96
- Managing Routes 68
- Managing Tracks 81
- Managing Waypoints 72
- Man OverBoard 86
- MapSource 10, 134
- Map Data 106
- Map Data Information 150
- Map Datum 140

- Map Orientation 30
- Map Page
 - Automotive Mode 63
 - Aviation Mode 29–34
 - Declutter 33
 - Marine Mode 87
 - Setup 34
- Marine Timer 89
- Maritime Mobile Service Identity.
 - See MMSI
- Marking a Waypoint 9, 26, 57, 58, 59, 75
 - Underwater 122
- Mark my Location 26
- Maximum Speed 45
- MayDay 93, 142
- Measuring Distance 33
- Messages 102, 145, 147–151
- Military Time 111
- Mils 110
- MMSI 90, 141, 142
- MOB 86
- Modes 49, 109
- Moon Information 98
- Move around the Map 31

N

- Navigate
 - Route 69
 - To Point 86
- Track 84
- Navigating in Automotive Mode 50–51
- Navigating in Marine Mode 86
- Navigation Alarms 95
- NDB 18, 143
- Near
 - Current Route 53, 54
 - Destination 53, 54
 - Next 53, 54
 - Other 53, 54
- NEAREST/FIND key 18
- Nearest Type 43, 67
- New
 - Altitude 6
 - Location 6, 11
 - Waypoint 59, 75
- Next Turn 95, 113
- NMEA 115, 116, 117, 135
- North Up 6, 30
- No Beacon Signal 137

O

- OBS 39
- Obstacle Alert 28
- Odometer 67
- Off-Route Recalculation 113
- Off Course 95
- Off Road 112
- On-Screen Button 8

Options Menu 9
 OUT key 7
 Overzoom 30

P

PAGE Key 7
 Page Layout 105
 Page Sequence 85
 Panel Page
 Aviation Mode 38–41
 Panning the Map 29, 31
 Pan Mode 29, 31
 PC Interface Cable 133
 Persistent Alarm 94
 Plan Flight 42, 71, 97
 Plan Route 42, 71
 Point 97
 Points of Interest 52
 Points Tab 77
 Pop-up Alerts 28
 Position 136
 Position Data Page
 Aviation Mode 43
 Position Mode 29
 Position Report 90–93, 141–142
 Power 2, 3, 132
 Connector 1, 4
 Power Outlet 2
 Practice Mode. *See* Simulator Mode
 Preferences

 Location 140
 Pressure 110
 Projecting a Waypoint 75–80
 Project Location 75
 Proximity 80
 Alarms 80
 Points Tab 79
 Waypoint 80

R

Receiver Not Usable 5
 Receiver Status 5
 Receive Satellite Signals 3
 Receiving a DSC Call 92
 Record Mode 81, 84
 Reference Position 53
 Registration 147–149
 Release Hold 39
 Reset Timer 110
 Reset Trip 43, 67
 Retrace your Path 84
 Review
 Route 69
 Waypoint 72
 Road 64
 Road Routing Tab 112
 Route 70, 84, 97
 Add Points 70
 Add Waypoint to 74
 Edit 70, 71

 Editing 61–62
 Leg Transition 68
 Options Menu 68
 Preference 112
 Routes 55–56, 136
 Automotive Mode 68–71
 Editing 68–71
 Navigating a Saved Route 69–71
 Route tab 68
 Routing and Guidance Settings
 112–113
 RTCM 115, 116
 Runway Criteria 22

S

Safety and Product Information
 147–151
 Safety Information 149
 Sail Boat Racing Timer 89
 Satellite Acquisition 5
 Saved Route 27, 68
 Saved Track 84
 Saved Tracks 83
 Save Present Location 57
 Save Track Log 82
 Saving the Current Route 66
 Scanning for Beacon 137
 Scan for a Frequency 116
 Scroll Bar 8
 Searching the Sky 5
 Search History 53
 Selecting an Approach 23–24
 Selecting Options 9
 Sentences 117, 135
 Serial Communications Port 133
 Serial Data Format 115
 Serial Number 1, 147
 Setting Alarms 94–96
 Setting up the System 104–111
 Setup Tab
 Guidance Tab 113
 Road Routing Tab 112
 System Tab 109
 Timers Tab 110
 Time Tab 111
 Units Tab 110
 Welcome Tab 104
 Set an Alarm 94
 Set CDI Scale 39
 Set Date 111
 Set OBS and Hold 39
 Set Speed and Fuel 42, 71
 Show Details 16
 Show Map 73
 Signal Strength 5
 Simulated Navigation 11–13
 Sonar 118, 119–122
 Adjusting 120–122
 On the Map Page 118
 Setting Up 123, 125

- Understanding 126
 - Sonar Alarms 96
 - Sound Tab 108
 - Speaker 108
 - Specifications 129
 - Speed 38, 45
 - Speed Filter 109
 - Split Screen, Sonar 122
 - Storage 130
 - Sun & Moon Tab 98
 - Switch Modes 14, 49, 85
 - System Alarms 96
 - System Tab 109
- T**
- Temperature 103, 110
 - Terrain
 - Alert 28
 - Terrain Page
 - Aviation Mode 35–37
 - Declutter 33
 - Terrain Warning 36
 - Text Language 109
 - Thermoclines 128
 - Tide
 - Chart 100
 - Information 99
 - Station 100
 - Tab 99
 - Time
- Delay 138
 - Format 111
 - Offsets 140
 - Tab 111
 - Zone 111
- Timer 89
 - Timers Tab 110
 - Toll Roads 113
 - Toll Roads 113
 - Track
 - Legs 84
 - Log 81, 82, 84
 - Review Page 82, 83
 - Tab 81
 - TracBack 83, 84
 - Track Up 6, 30
 - Transducer 123, 127
 - Trip Computer 67
 - Trip Planning 71, 97
 - True Airspeed 48
 - Tuning Beacon 137
 - Turn-by-Turn Route 13, 50, 60, 69
 - Turn On and Off 3
- U**
- U-Turns 113
 - Underwater Waypoints 122
 - Units Tab 110
 - Unpaved Roads 113
 - Updates to Jeppesen Database 143
- Usage Mode 14, 109
 - Usage Restrictions 17
 - USB 115
 - Data Cable 133
 - User Points Tab 77
 - UTC 111
 - UTM/UPS 140
- V**
- Vectors 24
 - Vertical Navigation. *See* VNAV
 - Vertical Speed 110
 - VHF 90, 141
 - View Details 31
 - VNAV 40, 41
 - Indicator 40
 - Profile 41
 - Voice Language 108
 - Volume 3, 108
 - VOR 18, 143
- W**
- WAAS 6, 109, 132, 136, 137
 - Warning Page 3
 - Waterproof 130
 - Water Speed 124
 - Water Temp 96
 - Waypoint 16, 26, 57–59, 136
 - Categories 76, 77
 - Create 26, 58, 75
- Edit 72, 73
 - Information Page 54
 - Management 72
 - Mark 9, 26
 - Name 73
 - Proximity 80
 - Symbol 73
 - Transition 68
 - Weight & Balance 46
 - Whiteline 121, 128
 - Wide Area Augmentation System.
See WAAS
 - Winds Aloft 48
 - Wx 18
- X**
- X symbol on Terrain 35
- Z**
- Zoom 30

For the latest free software updates (excluding map data) throughout the life of your
Garmin products, visit the Garmin Web site at www.garmin.com.



© Copyright 2004 Garmin Ltd. or its subsidiaries

Garmin International, Inc.
1200 East 151st Street, Olathe, Kansas 66062, U.S.A.

Garmin (Europe) Ltd.
Unit 5, The Quadrangle, Abbey Park Industrial Estate, Romsey, SO51 9DL, U.K.

Garmin Corporation
No. 68, Jangshu 2nd Road, Shijr, Taipei County, Taiwan

www.garmin.com

Part Number 190-00337-00 Rev. C